

Tulsa Health Department

# Pool Operators Permit Instruction Manual

Environmental Health Services  
5051 S. 129th E. Ave.  
Tulsa, OK 74134  
918.595.4200

# **POOL OPERATORS INSTRUCTION MANUAL**

This instruction manual is designed to educate pool operators and provide guidelines for the safe operation of swimming pools. The Tulsa City-County Health Department disclaims any responsibility for improper pool maintenance.

The terms: "pool", "swimming pool", "spa", or "hot tub" used individually or together in this manual shall be understood to mean any public bathing place.

This manual is not to be considered a substitute for legal counsel. Any questions about the interpretation of state or local codes concerning swimming pool or spa operations should be addressed to the Tulsa City-County Health Department and/or the State Health Department.



# What's Wrong With This Picture?

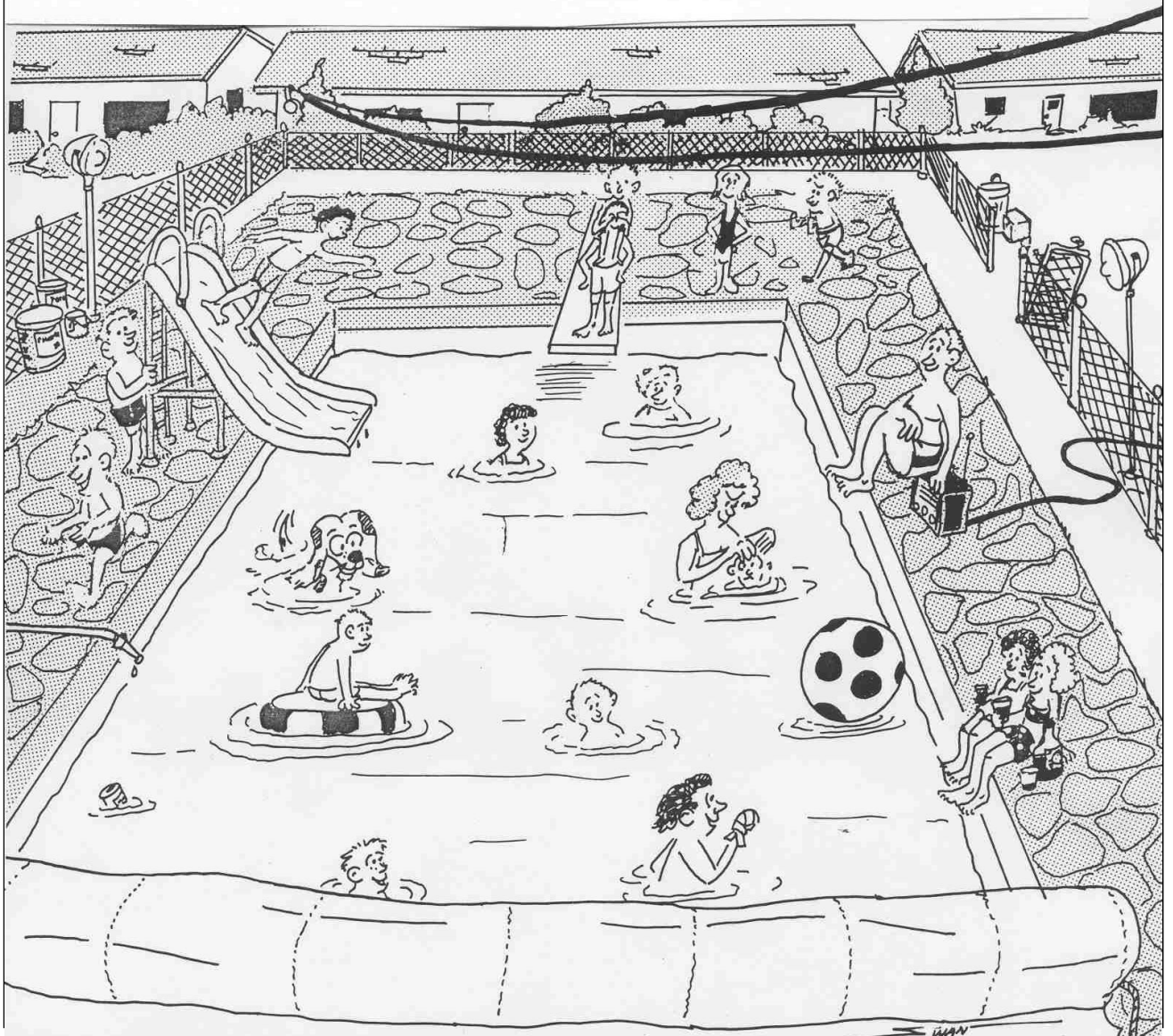

## SEEK & FIND

- |         |          |          |
|---------|----------|----------|
| 1 _____ | 9 _____  | 17 _____ |
| 2 _____ | 10 _____ | 18 _____ |
| 3 _____ | 11 _____ | 19 _____ |
| 4 _____ | 12 _____ | 20 _____ |
| 5 _____ | 13 _____ | 21 _____ |
| 6 _____ | 14 _____ | 22 _____ |
| 7 _____ | 15 _____ | 23 _____ |
| 8 _____ | 16 _____ |          |



# TABLE OF CONTENTS

## Part I — Instruction Manual

### Section 1 - Pool and Spa Calculations 1-1

Section 2 - Basic Circulation System .....	2-1
Section 3 - Sanitizers .....	3-1
Section 4 - Water Balance .....	4-1
Section 5 - Chemical Dosage .....	5-1
Section 6 - Spas .....	6-1
Section 7 - Chemical Safety .....	7-1
Section 8 - Troubleshooting .....	8-1
Section 9 - Preventative Maintenance .....	9-1

## Part II — CHAPTER 320. PUBLIC BATHING PLACE OPERATIONAL REGULATIONS

### Subchapter

1. General Provisions .....	310:320-1
3. Operational Provisions.....	310:320-3
5. Forms and Tables.....	310:320-5

Appendix



## SECTION 1 - POOL AND SPA CALCULATIONS

### A. EQUIVALENTS:

Square Foot (sq. ft.) - a square 12" wide and 12" long

Cubic Foot (cu. ft.) - a cube 12" wide by 12" long by 12" high

Cubic Yard (cu. yd.) - a cube 36" wide by 36" long by 36" high

One cubic foot of water contains 7.48 gallons

One cubic foot of water weighs 62.4 pounds

One gallon of water weighs 8.33 pounds

One part per million (ppm) - represents 8.3 pounds of chemical  
per million gallons of water

### B. GEOMETRIC FORMULAS

A simple method of calculating pool size is the use of geometric formulas. Following are basic formulas:

A = Area

L = Length

W = Width

H = Height

r = radius = 1/2 diameter

$\pi$  = pi = 3.14 (a constant)

$\pi r^2$  = area of a circle



## C. CALCULATION FORMULAS

### 1. Amount Conversions

Ounces to Pounds .....Ounces  $\div$  16 = Pounds  
Fluid Ozs. to Gallons.....Fluid Ozs.  $\div$  128 = Gallons

### 2. Distance Conversions

Yards to Feet .....Yards X 3 = Feet  
Meters to Feet.....Meters X 3.28 = Feet

### 3. Surface Areas

Rectangle/square.....Length x Width = Square Feet  
Circle .....3.14 x Radius x Radius = Sq. Ft.  
Radius .....Diameter  $\div$  2

### 4. Pool Volume

Length x Width x Average Depth x 7.48 = Gallons  
Average Depth = Shallow + Deep  $\div$  2

### 5. Turnover Rate

The amount of time needed to recirculate the entire volume of the pool or spa one (1) time. Measured in hours.

Pool Volume  $\div$  Flow Rate  $\div$  60 = Hours

### 6. Flow Rate

The amount of water passing through the recirculation and filtration system at a given time. Measured in gallons per minute (GPM). A flow meter measures flow rate.

Pool Volume  $\div$  Required Turnover Rate (Hrs)  $\div$  60 = Gallons Per Minute (GPM)



3. Surface Area of a Circle

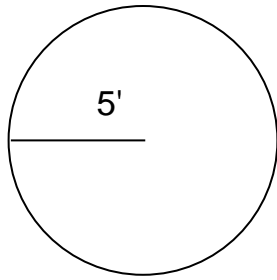

---

---

---

---

---

---

---

---

---

---

---

---

---

---

---

$$A = \pi r^2 \quad (\pi = 3.14 \text{ \& } r = 1/2 \text{ diameter})$$

$$A = 3.14 \times 5^2$$

$$A = 3.14 \times 25 \text{ sq. ft.}$$

$$A = 78.5 \text{ sq. ft.}$$

**E. MAXIMUM USER CAPACITY**

1. Pools

Swimming Area..... Surface Area  $\div$  15 = Load Limit

Diving Area ..... Surface Area  $\div$  24 = Load Limit

2. Spas - Larger Than 450 gallons

1 person per 3 linear ft. of spa perimeter, or  
1 person per 200 gallons of water (whichever is less)

3. Spas - Smaller Than 450 gallons

1 person per 150 gallons

## F. CALCULATING POOL VOLUME (GALLONS)

### 1. Calculating Average Depth

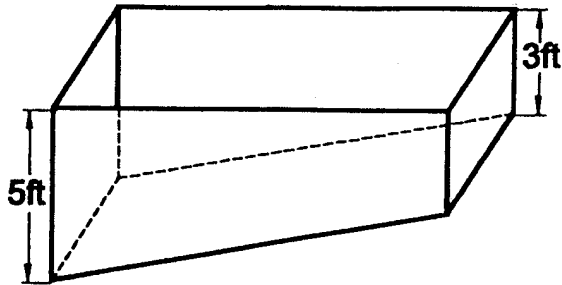

---

---

---

---

---

---

---

---

Deep End + Shallow End  $\div$  2 = Avg. Depth  
(5' + 3' = 8  $\div$  2 = 4' Average Depth)

---

---

### 2. Volume of Square or Rectangular Pool

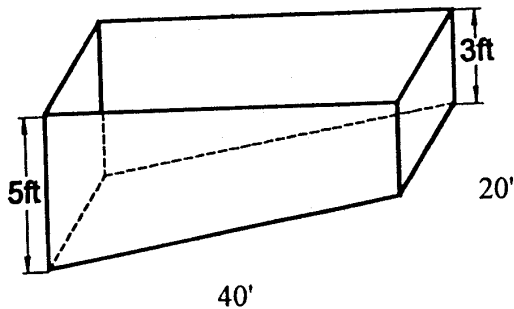

---

---

---

---

---

---

---

---

Volume = L x W x Average Depth x 7.48  
(40' x 20' x 4' x 7.48 = 23,936 gallons)

---

---

---

---

---

---

---

---

3. Volume of Circular Pool

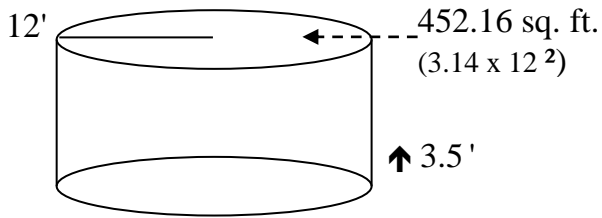

Volume = Surface Area x Average Depth X 7.48  
(452.16 x 3.5 x 7.48 = 11,837.5 gallons)

---

---

---

---

---

---

---

---

---

---

4. Volume of Kidney-Shaped Pool

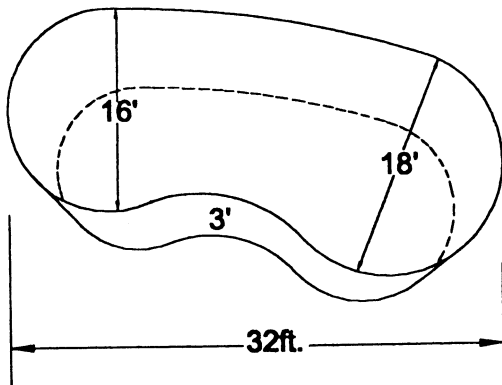

$A + B \times L \times .45 \times \text{Avg. Depth} \times 7.48$   
(16 + 18 x 32 X .45 x 3.0 x 7.48 = 10,987 gallons)

16 + 18 = 34  
34 x 32 = 1,088  
1,088 x .45 = 489.6  
489.6 x 3.0 = 1,468.8  
1.468.8 x 7.48 = 10,987 (rounded up)

---

---

---

---

---

---

---

---

---

---

---

---

---

---

---

---

---

---

---

---

---

---

---

---

## Calculations

## Practice Worksheet

Surface Area (Formula:  $L \times W = \text{Surface Area}$ )

Length	Width	Surface Area
65'	25'	
40'	20'	
80'	40'	
50'	25'	
60'	30'	

Average Depth (Formula:  $S + D \div 2 = \text{Average Depth}$ )

Shallow	Deep	Average Depth
3'	5'	
4'	10'	
0'	8'	
3'	1'	
5'	12'	

Gallons (Formula  $L \times W \times \text{Average Depth} \times 7.48 = \text{Gallons}$ )

Length	Width	Shallow	Deep	Gallons
40'	20'	3'	5'	
50'	20'	5'	11'	
60'	30'	3'	5'	
35'	20'	3'	5'	
20'	10'	3'	3'	

Bather Load – Pool with No Diving Board (Formula:  $\text{Surface Area} \div 15$ )

Length	Width	Bather Load
65'	25'	
40'	20'	
80'	40'	
50'	25'	
60'	30'	

## Practice Worksheet (Continued)

Bather Load – Spa (Formula: 3' per person of Spa seating)

Seating Bench	Bather Load
12'	
8'	
9'	
16'	



## Calculations

# BASIC CIRCULATION SYSTEM

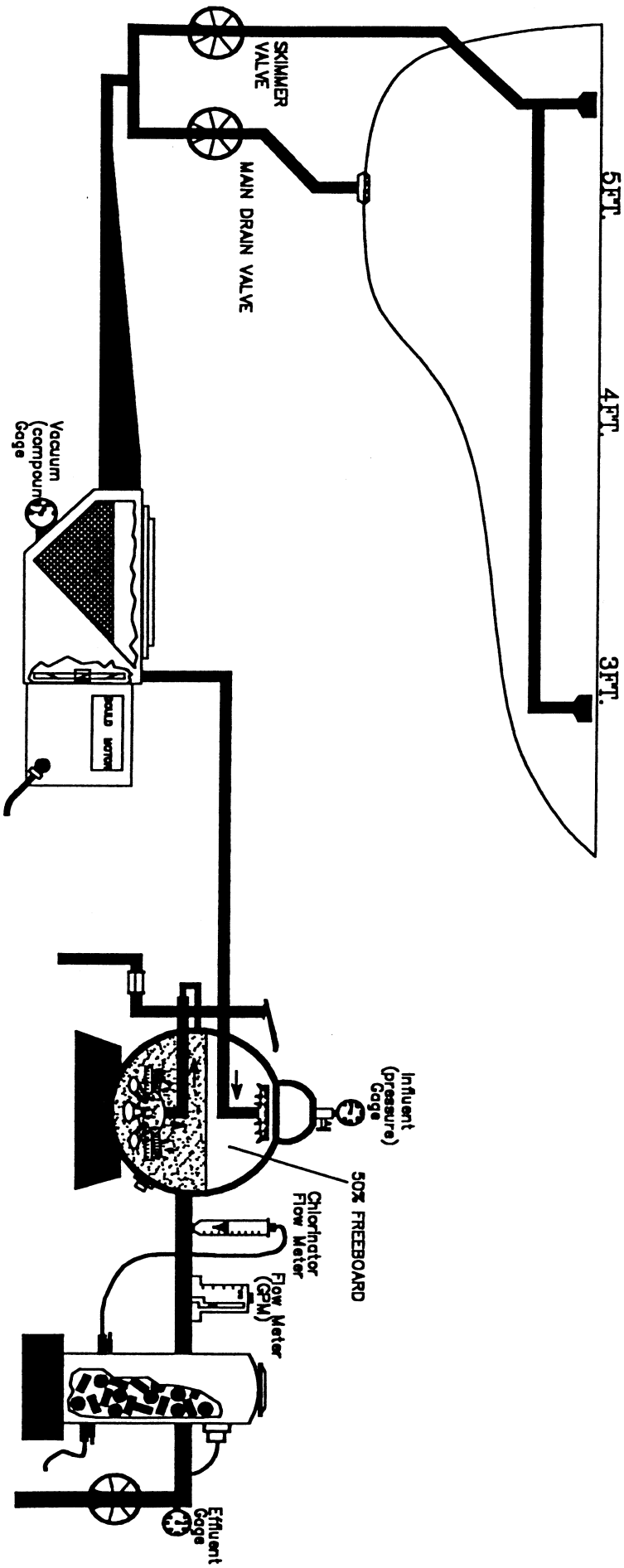



## **SECTION 2 — BASIC CIRCULATION SYSTEM**

### **A. OVERFLOW TROUGHS & SKIMMERS**

1. 50% or more circulated water should pass through the skimmers or overflow troughs (75% skimmers/25% main drain recommended).
2. Weir or trough creates waterfall with thin layer of surface water (1/8" - 1/4"). This effect increases water velocity ensuring maximum surface skimming action.

### **B. MAIN DRAINS**

1. For bottom collection of water.
2. Install proper covers that meet the ANSI/ASME A112.19.8-2007 standard (Virginia Graeme Baker) on every drain .
3. Install Safety Vacuum Release System (SVRS) of some type if the pool operates off of a single main.

### **C. SURGE OR BALANCE TANKS**

1. Hold displaced water from pool overflow due to active swimmers or overcrowded conditions. Helps establish hydraulic equilibrium.
2. Each swimmer will displace 20 gallons of water.

### **D. VALVES**

1. Regulate flow of water through the system.
2. Many types and brands (Gate, Float, Ball, Butterfly).

## E. HAIR & LINT STRAINERS

1. Screens the pump from large debris that could clog or damage the impeller.
2. Hair & lint strainers should be checked and cleaned at each filter cleaning.

## F. PUMP & MOTOR

1. Pump capacity is measured in ***gallons per minute (GPM)*** and head pressure (resistance) is expressed in ***pounds per square inch (PSI)***.
  - ◆ Head pressure is also known as Total Dynamic Head (TDH).
2. Almost all swimming pool and spa pumps are classified as centrifugal pumps.
3. The ***Impeller*** spins in the volute, creating pressure, which moves water.

## G. TYPES OF FILTERS

1. Rapid Rate Sand (Sand & Gravel)
  - ◆ Multiple Large Tanks
  - ◆ Multiple layers of sand and gravel
  - ◆ Vacuum or pressure systems
  - ◆ Filtering rate is 3 GPM per sq. ft.
  - ◆ Must be backwashed individually
  - ◆ Flocculants is a compound usually used with sand-type filters to form a thin layer of gelatinous substance on the top of the sand. Flocculants are recommended.

## 2. High Rate Sand

- ◆ One large tank or multiple tanks — vertical or horizontal
- ◆ Single layer of sand (in addition, single layer of pea gravel 1/4" to 1/8" diameter may be used to protect the laterals)
- ◆ Always pressure system
- ◆ Filtering rate is 15 GPM per sq. ft.
- ◆ May be backwashed collectively
- ◆ Flocculants NOT recommended
- ◆ The amount of freeboard is normally 50% of the sand depth
- ◆ Must be NSF approved

(Backwashing: reversing flow through a filter to clean it)

Filter Size – High Rate Filter (Formula:  $\text{GPM} \div 15 = \text{Filter Size}$ )

GPM	Filter Size
42	
84	
116	
66	

## 3. Diatomaceous Earth (D.E.)

- ◆ Single tank with multiple screens or leaves (grids) to hold filter media (diatomaceous earth)
  - ✓ D. E. coats screens or leaves (grids) to provide filtering
- ◆ D. E. may be precoated or slurry (body) fed
- ◆ Vacuum or pressure systems
- ◆ Filtering rate is 2.5 GPM per sq. ft. of surface area
- ◆ May be backwashed or manually cleaned

- ✓ Manually clean grids using TSP (trisodium phosphate) and water
- ✓ Disposal of waste water through adequately sized separation tank
- ◆ Must be NSF approved

#### 4. Cartridge

- ◆ Single or multiple pleated elements composed of synthetic fibrous material (usually polyester) attached to a cylindrical core
- ◆ Normally used on pressure systems
- ◆ Filtering rate is .375 to 1.0 GPM per sq. ft. (.375 GPM/sq. ft.)
- ◆ Must be manually cleaned
  - ✓ Clean with TSP (trisodium phosphate) and water
  - ✓ Use 10 to 1 diluted solution of muriatic acid to remove scale (Caution: If acid is used first, it will set oils.)
- ◆ Must be NSF approved

## H. GAUGES & METER

1. Monitor system performance (mandatory for optimum efficiency).
2. Influent and effluent pressure gauges monitor filters to indicate need to backwash or clean.
  - ◆ When influent pressure increases and effluent pressure decreases, clean filter (normally, 8 to 10 pound differential)
3. Flow Meters measure the speed that the water is moving through the system.

- ◆ Measured in gallons per minute (GPM)

## **I. CHEMICAL FEEDERS**

1. Chemical Feeders feed needed chemicals automatically.
  - ◆ Erosion chlorine or bromine feeders
  - ◆ Peristaltic and diaphragm pumps feed liquid chlorine and pH adjusting chemicals
  - ◆ Gas chlorinators are vacuum operated solution feed design using venturi-operated injector
  - ◆ Must be NSF approved
2. Automation (controllers) monitors sanitizer and pH and direct chemical feeders to add chemicals as required.

## **J. PIPING**

1. Connects all equipment and fittings.
2. Size, length, and number of elbows determined by designer.
3. Amount of flow is limited by pipe size.
4. Label pipes as to direction of flow of water.
5. Must be NSF approved.

## **K. INLETS OR RETURNS**

1. In-wall or in-floor return of filtered, heated and chemically treated water.
  - ◆ Important for directing circulation pattern of pool — equal distribution



- ◆ Pattern should move toward deep end and from bottom to surface

## L. CALCULATING FILTER SURFACE AREAS

1.

Filter Type	Minimum Required Flow
High Rate Sand Filter	15 GPM per sq. ft.
D.E.	2.5 GPM per sq. ft.
Cartridge	.375 GPM per sq. ft.

Pools and spas built after 1982 with skimmers shall have a minimum flow of 43 GPM per skimmer. Use whichever flow rate is higher.

2. Minimum Required Turnover Rate:

Pool (8 hr. turnover)	gallons ÷ 480 = GPM
Wading Pools (4 hr. turnover)	gallons ÷ 240 = GPM
Spas (30 minute turnover)	gallons ÷ 30 = GPM

Public pool filter systems must be capable of maintaining a flow rate at its code capacity even when being stressed or clogged by particulate matter or debris.

Sizing the pump and filter 25% larger than required will ensure adequate circulation as the filter becomes dirty.

## SECTION 3 — SANITIZERS

### A. CONTROL OF WATER CONTAMINANTS

#### 1. Sanitation

The process of destroying organisms that are harmful to people.

#### 2. Oxidation

The process of chemically removing organic debris from the water.

#### 3. Algaecides

Algaecides control the growth of algae in pool or Spa water

Chlorine sanitizes, oxidizes and controls algae growth.

### B. TYPES OF CHLORINE

#### 1. Unstabilized (No \*CYA)

- ◆ Calcium Hypochlorite — 65% available chlorine  
pH = 10.8 - 11.8
- ◆ Sodium Hypochlorite (Liquid) — 10 - 15% available chlorine  
pH = 13.0
- ◆ Lithium Hypochlorite (Granular) — 35% available chlorine  
pH = 10.7
- ◆ Chlorine Gas (Gas) — 100% available chlorine  
pH = < 1.0

## 2. Stabilized - Contains Cyanuric Acid (CYA)

- ◆ Sodium Dichlor — 55% available chlorine  
pH = 6.8 - 7.0
- ◆ Trichlor — 90% available chlorine  
pH = 2.8 - 3.0

### Cyanuric Acid (Stabilizer)

- Sunlight destroys/degrades chlorine rapidly (90% of residual in 2 to 3 hours).
- Cyanuric acid acts as sunscreen and cuts out up to 90% of the burn off.
- Ranges:  
Minimum = 10 ppm  
Ideal = 30 to 50 ppm
- Cyanuric acid is not required for indoor pools/spas, or pools/spas that use bromine. The cyanuric acid level should be maintained between 10 to 50 ppm if the pool/spa has a ORP/pH controller. (as cyanuric acid levels increase, ORP levels decrease).

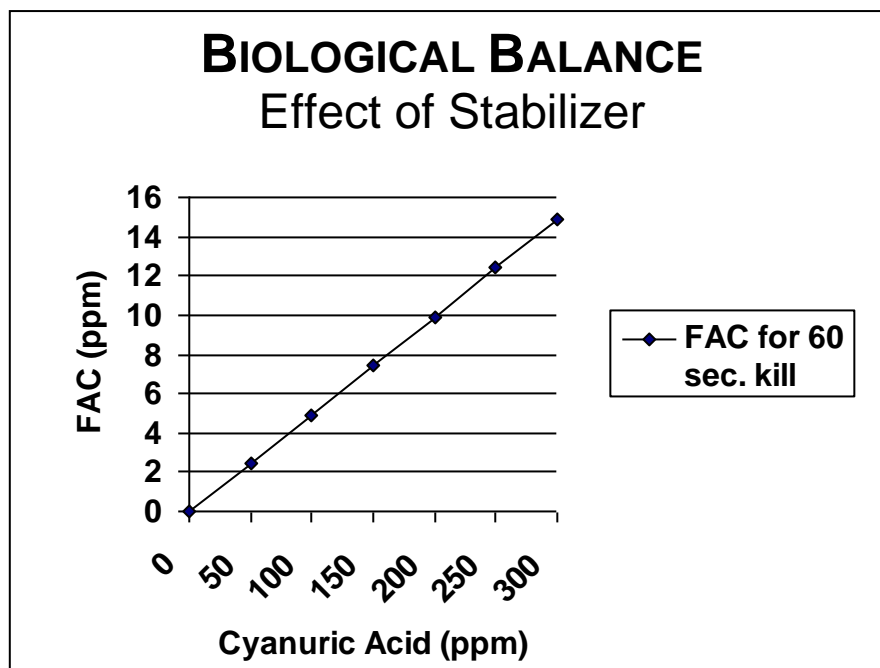

## C. CHLORINE RESIDUAL

1. A sanitizer must be continually active. It must provide a measurable residual.
2. When any type of chlorine is added to water, it forms hypochlorous acid (HOCl) and hypochlorite ions (OCI). Together these two compounds are Free Available Chlorine (FAC). We can measure FAC, TAC and CAC with a DPD test kit. Always maintain a minimum 1.0 ppm of FAC at all times.

- ◆ (FAC) = Free Available Chlorine Min. 1.0 ppm

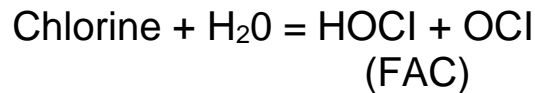

- ◆ HOCl = Hypochlorous Acid

Unstable, Active Killing Form of Chlorine

- ◆ OCI = Inactive Form of Chlorine

- ◆ Total Available Chlorine (TAC)

Total of all chlorine compounds in water

- ◆ Combined Available Chlorine (CAC)

Chloramines (TAC - FAC = CAC) NOT TO EXCEED 0.2 PPM

3. Chlorine is pH dependent. Proper pH = maximum killing power and dollars saved. See Figure 3.1 on next page.

## D. BROMINE RESIDUAL

1. Has a pH of 4.0 to 4.5
2. Operating range is 2.0 to 4.0 ppm
3. Like chlorine, bromine combines with organic impurities to form combined bromines or bromamines. However, combined bromine is still an effective sanitizer and it does not smell. Because of this, bromine is popular for spas.

## pH DOES MAKE A DIFFERENCE

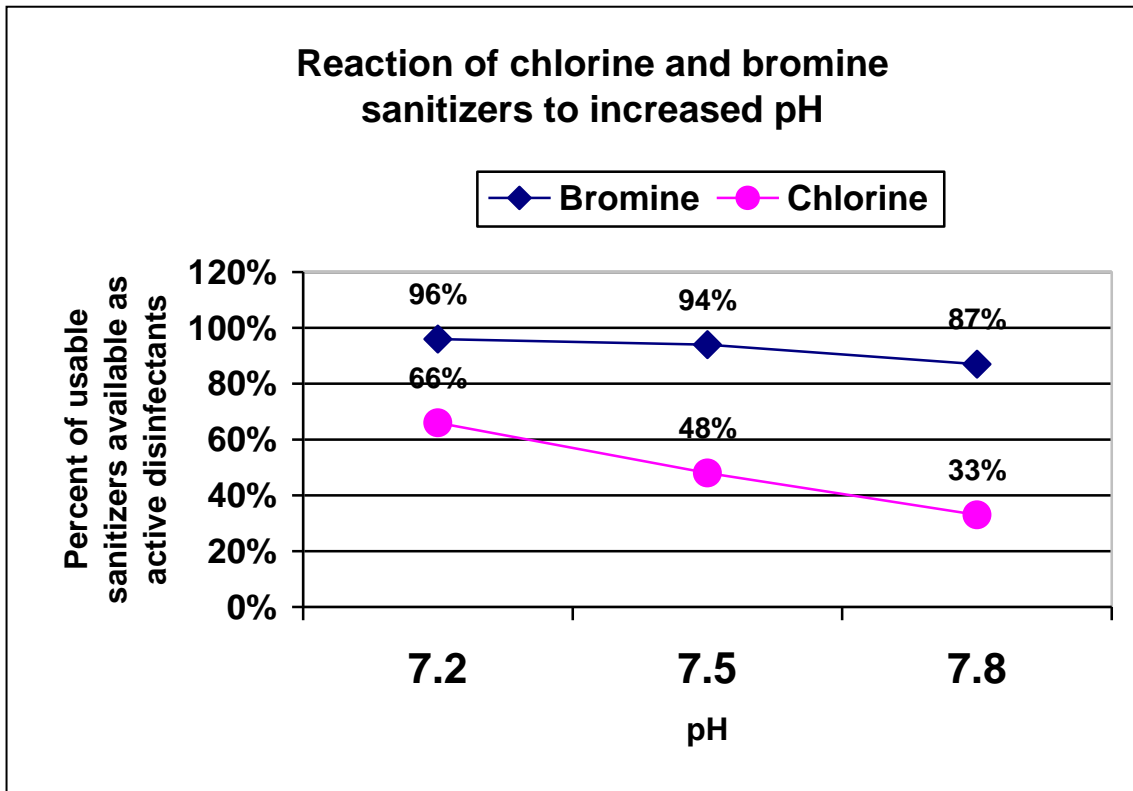

Figure 3.1

### **E. COMBINED AVAILABLE CHLORINE (CAC)**

1. The chlorine in a pool or spa can become "tied up" with contaminants (usually swimmer waste, rain, etc. - mostly nitrogen and ammonia) forming Combined Available Chlorine (CAC, or chloramines). Chloramines are:

- ◆ Body, eye and skin irritants
- ◆ Foul smelling

2. Definitions:

- ◆ Weak disinfectant (40-60 times less effective than FAC)
- ◆ Oxidized nitrogen compounds

## F. SUPERCHLORINATION

1. Process of eliminating CAC from water by adding a large dose of chlorine to reach chlorine breakpoint.
2. Breakpoint Chlorination - the point in a rising chlorine residual at which the concentration of available chlorine becomes great enough to completely oxidize all organic matter and ammonia compounds in a pool.

To calculate the amount of chlorine required to reach breakpoint, test the FAC and TAC with a DPD test kit. This shall be done while the pool is not in use.

- ◆  $TAC - FAC = CAC$
- ◆ Multiply CAC x 10
- ◆ Total equals ppm needed to reach breakpoint

### PROBLEM

25,000 gallons









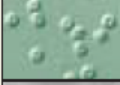

$$\begin{array}{r} TAC \quad 3.0 \\ FAC \quad \underline{-2.0} \\ CAC \quad 1.0 \end{array} \quad X \quad 10 = 10 \text{ ppm for breakpoint} \\ \text{for superchlorination}$$

1.25 lbs. per 10,000 gallons of water will approximately raise the chlorine level up 10 ppm.

## G. SUPPLEMENTAL TREATMENTS

1. Potassium monopersulfate – non-chlorine shock
2. Sodium chloride – electrolysis of salt
3. Ozone – strong oxidizer and disinfectant generated on site through UV light or electrical sparks
4. Ionizer – Use copper as algistat and/or silver as bacteriostat

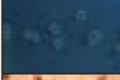
All supplemental treatments have advantages and disadvantages. In all cases, you are still required to maintain a chlorine residual in addition to the supplemental treatment.

	Pathogen	Type	Method of transmission	Symptoms	Incubation rates	Chlorination time
	Cryptosporidium	Parasite	Swallowing contaminated water. Is very contagious, through people-to-people contact.	Dehydration, weight loss, stomach cramps, fever, nausea, vomiting. No treatment.	2 to 12 days	About 9,600 minutes (6.7 days)
	Escherichia coli (E. coli)	Bacteria	Swallowing contaminated water	Severe bloody diarrhea, abdominal cramps, kidney failure. Antibiotics available.	3 days	Less than one minute
	Giardiasis	One-celled parasite	Swallowing contaminated water. Cysts can survive in cold water for months.	Diarrhea, gas, greasy stools, stomach cramps, upset stomach, nausea. Prescription drugs available.	1 to 2 weeks	About 45 minutes
	Hepatitis A	Virus	Swallowing water contaminated with feces infected with virus	Jaundice, fatigue, stomach pain, loss of appetite, nausea, diarrhea, fever. No real treatment. Vaccine available.	2 weeks to 6 months	About 16 minutes
	Legionnaires' disease/Pontiac Fever	Bacterium Legionella pneumophila	Breathing mists from hot tubs infected with the bacteria. Not contagious.	Fever, chills, cough, muscle aches, headache, fatigue, diarrhea, kidney malfunction. Legionnaires' treatable.	2 to 14 days	Less than one minute
	Naegleria Infection	Microscopic ameba	Enters through nose and travels to brain and spinal cord. Feeds on brain tissue. Very rare infection.	Causes primary amebic meningoencephalitis (PAM), a brain inflammation. Drugs available; high fatality rate.	3 to 7 days	Less than one minute
	Norovirus Gastroenteritis	Virus	Swallowing water contaminated with stool carrying the virus. Very contagious.	Nausea, vomiting, diarrhea, stomach cramping, fever, chills, muscle aches, fatigue. Most recover in 1-2 days.	1 to 2 days	About 30 minutes to an hour
	Pseudomonas Dermatitis (Hot Tub Rash)	Bacteria	Direct skin contact with contaminated water. Usually in hot tubs, but also in pools.	Itchy skin, red rash, blisters around hair follicles. Clears up on its own within a few days.	8 hours to 5 days	Less than one minute
	Salmonellosis	Bacteria, Salmonella	Swallowing water contaminated with bacteria	Diarrhea, fever, cramps. Antibiotics if infection spreads from intestines; no necessary treatment otherwise.	1 to 3 weeks	Less than one minute
	Shigellosis	Bacteria Shigella	Swallowing water contaminated with bacteria	Bloody diarrhea, fever, cramps. Antibiotics, though forms of shigella have become resistant.	12 to 15 hours	Less than one minute

SOURCE: CENTERS FOR DISEASE CONTROL AND PREVENTION

## **PROCEDURES FOR FECAL AND VOMIT ACCIDENTS**

### **A. NORMAL DISCHARGE (CONTAINED, FORMED STOOL)**

Instruct patrons to exit pool. Close the pool until all steps in this guideline are completed. Remove the visible feces. Add chlorine to the affected area (either 1 oz. of calcium hypochlorite or 4 to 5 ounces of sodium hypochlorite which has been mixed in a small bucket of water). Record the incident on your Bathing Place Operation Record. Wait approximately 30 minutes to ensure chlorine level and pH level meets the requirements as per code.

### **B. WATERY FECAL DISCHARGE OR VOMIT**

Watery fecal discharge or vomit presents the greatest likelihood of carrying harmful pathogens. All the following steps are to be followed when fecal matter is detected in the pool:

1. Immediately clear the pool.
2. Remove all visible physical fecal or vomit matter.
3. Raise the chlorine residual to a minimum of 20 ppm.
4. Maintain a pH level at or near 7.5 for at least 8 hours.
5. Backwash filters.
6. Then lower the chlorine to 5 ppm using sodium thiosulphate.

When watery fecal discharge or vomit occurs in spas or wading pools, the following steps should be taken:

1. The spa or pool shall be drained.
2. Brush the side and bottom with 100 ppm chlorine.
3. Refill the spa or pool and balance the water per code.

Pool operators should focus on preventing the watery accident. Educate parents to put swim diapers on your children, to teach their children appropriate places to go potty and, especially, not to drink pool water. Children and adults who have had diarrhea in the past month should not go swimming. This education can be done through signs, conversations, handouts or community newsletters.





## SECTION 4 — WATER BALANCE

### A. BALANCE

1. If pH, Total Alkalinity and Calcium Hardness are within recommended ranges

AND

The water is correctly saturated with calcium carbonate

THEN

There is no tendency to corrode or scale

2. Calcium carbonate is found in all water
3. Calcium, the least soluble mineral, can become under or oversaturated
4. Calcium carbonate precipitate forms scale

### B. pH

1. pH is a value that determines how acidic (corrosive) or basic a solution is. pH is a temporary condition.

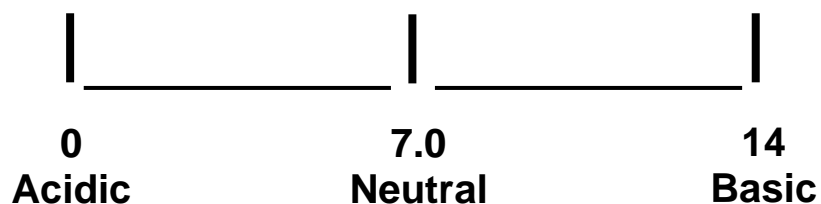

2. pH is important for 3 reasons:

- (1) Vessel and equipment protection
- (2) Swimmer comfort
- (3) Sanitizer effectiveness

Low pH	High pH
<ol style="list-style-type: none"><li>1. Etched plaster</li><li>2. Corroded metals</li><li>3. Stained plaster</li><li>4. Eye and skin irritation</li><li>5. Destruction of Total Alkalinity</li><li>6. Chlorine unstable</li></ol>	<ol style="list-style-type: none"><li>1. Scale formation</li><li>2. Cloudy water</li><li>3. Short filter runs</li><li>4. Eye and skin irritation</li><li>5. Poor chlorine efficiency</li></ol>

3. Ranges:

Acceptable = 7.2 to 7.8

Ideal = 7.4 to 7.6

4. Adjusting

To Raise: Use Soda Ash (sodium carbonate)

To Lower: Use Muriatic acid (liquid) or Dry Acid (sodium bisulfate)

Always test and adjust total alkalinity before testing and adjusting pH.

### C. TOTAL ALKALINITY

1. Measure of resistance to change of pH (buffering or acid neutralizing capacity of the water). The correct total alkalinity helps maintain pH.

Low Total Alkalinity	High Total Alkalinity
1. Etched plaster 2. Corroded metals 3. Stained plaster 4. Eye and skin irritation 5. Destruction of total alkalinity 6. Chlorine unstable	1. pH hard to change 2. Scale formation 3. Poor chlorine efficiency 4. Eye and skin irritation 5. Cloudy water

2. Ranges (based on type of sanitizer used):

Acceptable = 80 ppm to 200 ppm

- ◆ 80 - 100 ppm — Sodium hypochlorite, calcium hypochlorite or lithium hypochlorite
- ◆ 100 - 120 ppm — Gas, dichlor, trichlor and bromine

3. Adjusting:

To Raise: Use sodium bicarbonate

To Lower: Use Muriatic Acid (liquid) or Dry Acid (sodium bisulfate)

## D. CALCIUM HARDNESS

1. Measure of Calcium and Magnesium Dissolved in Water

Low Calcium Hardness	High Calcium Hardness
1. Corrosive water 2. Water foaming	1. Scale formation 2. Chemicals less effective 3. Cloudy water

2. Ranges: 50 - 500 ppm

Ideal = 200 to 400 ppm

Maximum = 500 ppm

3. Adjusting

To Raise: Use calcium chloride (least soluble chemical)

To Lower: Partially or completely drain pool and refill. Spas should be completely drained and refilled.

**Note:** Do not add calcium chloride the same day as soda ash or sodium bicarbonate as the water may turn cloudy.

## E. TOTAL DISSOLVED SOLIDS (TDS)

1. TDS is the sum total of all dissolved materials in the water.

2. A high TDS can result in:

- ◆ Salty-tasting water
- ◆ Colored but clean water
- ◆ Algae despite a good sanitizer level
- ◆ Corrosion of metal parts (4000 ppm)
- ◆ Cloudy Water
- ◆ Eye and skin irritation
- ◆ False test readings

3. Ranges: 300 - 1500 ppm

4. Adjusting:

To Lower - Partially or completely drain and refill pool.

## F. WATER GRAM BALANCE

It is the nature of water to dissolve the things it contacts until the water becomes saturated. A commonly used tool in determining the degree of saturation in pool water is the Water Gram. Use the following instructions:

1. Determine
  - ◆ pH
  - ◆ Total Alkalinity
  - ◆ Calcium Hardness
2. Set total alkalinity opposite calcium hardness.
3. Read pH of saturation opposite temperature.
4. Subtract pH of saturation from pH of sample water. This value equals saturation index. If saturation index is 0.5 or greater, water may become cloudy or deposit scale. If saturation index is 0.5 or less, water is corrosive.

Example:

Over Saturated	Balanced	Under Saturated
PH ..... 8.0 Total Alk. .... 150 Calcium Hardness ... 500 Temperature ..... 76°F	PH ..... 7.4 Total Alk. .... 100 Calcium Hardness.... 200 Temperature ..... 76°F	PH ..... 7.2 Total Alk. .... 50 Calcium Hardness .... 90 Temperature ..... 76°F
$  \begin{array}{r}  8.0 \\  - 7.1 \text{ (pH Saturation)} \\  \hline  + 0.9  \end{array}  $	$  \begin{array}{r}  7.4 \\  - 7.6 \text{ (pH Saturation)} \\  \hline  - 0.2  \end{array}  $	$  \begin{array}{r}  7.2 \\  - 8.3 \text{ (pH Saturation)} \\  \hline  - 1.1  \end{array}  $

## WATER BALANCE PROBLEMS

Problem 1	Problem 2	Problem 3
PH ..... 8.0 Total Alk. .... 150 Calcium Hardness ... 500 Temperature ..... 80°F	PH ..... 7.4 Total Alk. .... 100 Calcium Hardness.... 200 Temperature ..... 80°F	PH..... 7.2 Total Alk..... 50 Calcium Hardness ..... 90 Temperature ..... 80°F
Balanced:	Balanced:	Balanced:
Over Saturated	Over Saturated	Over Saturated
Under Saturated	Under Saturated	Under Saturated

## CHEMICAL STANDARDS

<b>Chemical</b>	<b>Minimum</b>	<b>Ideal</b>	<b>Maximum</b>
Free Chlorine (FAC)	Pool: 1.0 ppm Spa: 1.0 ppm	1.0 - 3.0 ppm 3.0 - 5.0 ppm	5.0 ppm 10.0 ppm
Combined Chlorine (CAC)	None	None	0.2 ppm
Bromine	Pool: 2.0 ppm Spa: 2.0 ppm	2.0 - 4.0 ppm 3.0 - 5.0 ppm	4.0 ppm 10.0 ppm
PH	7.2	7.4 - 7.6	7.8
Total Alkalinity	80 ppm	80 - 120 ppm <small>(Depends on type of sanitizer)</small>	200 PPM
	Calcium hypochlorite and lithium hypochlorite	80 - 100 ppm	
	Gas, dichlor, trichlor and bromine compounds	100 - 120 ppm	
Calcium Hardness	50 ppm	200 - 400 ppm	500 ppm
TDS	300 ppm		1500 ppm
Iron & Copper (Heavy Metals)	None	None	0.2 ppm
Stabilizer (Cyanuric Acid)	10 ppm	30 - 50 ppm	100 ppm
Hot Water Facilities-Water Temperature	90°F		105°F
Swimming Pools	75°F		90°F
Indoor Pool-Air Temp (Excluding Hot Water Facilities)	Water Temp -2°F		Water Temp +8°F
Turbidity	Must be able to clearly see main drain from pool sidewalk.		



## D. TESTING TECHNIQUES

The procedures for conducting the various pool tests are outlined in the instructions for your test kit. Regardless of the brand of the kit, the following guidelines should provide the most accurate results.

1. Conduct tests prior to adding chemicals.
2. Test a minimum of 4 times a day if pool is not automated (hourly for extremely heavy bather load).
3. Select well mixed samples - - away from return inlets - - 12" to 18 " down. In large pools, test the shallow and deep end.
4. Follow the instructions included with test kit.
5. Rinse test vials with pool water before and after each test.
6. Do not touch reagents, especially with dirty hands.
7. Do not interchange reagent caps and droppers.
8. Clean all testing equipment thoroughly after each use with clean, fresh water.
9. If the chlorine level is above 5.0, do not do the other tests; the readings will be invalid. High sanitizer levels can bleach the color of many common tests. Make sure to add a chlorine neutralizer to the test sample if the directions call for it.
10. To save time, fill both test vials simultaneously.
11. Hold test vial and dropper bottle vertically to ensure uniform drop size. Add test solution slowly, swirling or gently inverting after each drop. Never shake!
12. Read all test results immediately unless directed otherwise.
13. Compare colors out of sunlight and against a light or white background.

14. After adding reagents to the vials, do not return this water to the pool.
15. As with all chemicals, the test kit should be stored in a cool, dark place.
16. To ensure accurate and reliable tests, have the color standards checked once a year.
17. Replace test chemicals as needed.
18. Dilute high chlorine or cyanuric acid samples with distilled water to get accurate reading. Multiply reading by 2.



## SECTION 5 — CHEMICAL DOSAGE

### A. CHEMICAL DOSAGE TABLES

1. To use the chemical dosage tables<sup>1</sup>, test the water to determine what adjustments must be made. Once all the tests for water balance have been completed, and the need for treatment determined, the tables on the following pages can be used to find the correct amount of treatment chemical to add. For example, for a 30,000 gallon pool, the column value for 20,000 plus 2 times the 5,000 gallon column value will give an approximate amount of treatment chemical needed.

Examples:

To Superchlorinate a 50,000 gallon pool to 10 ppm using calcium Hypochlorite (65%), go to 50,000 column:

10.3 oz will raise chlorine level to 1 ppm  
10.3 oz times 10 = 103 oz  
103 oz ÷ 16 = 6.44 lbs.

Algae Removal - 30 ppm Shock

50,000 gallons using hypochlorite (65%) = 19.3 lbs.

Increase pH using Taylor Base Demand procedures

50,000 gallon pool, 4 Drop - use 6.41 lbs. Soda Ash

Increase Alkalinity

50,000 gallon pool to raise alkalinity from 60 ppm to 100 ppm use 28.0 lbs. sodium bicarbonate

<sup>1</sup> The tables are reprinted with permission from Pool & Spa Water Chemistry: A Testing and Treatment Guide, Copyright 1998 Taylor Technologies, Inc., Sparks, MD.

Table A  
Amount of Chlorine Compound to Introduce 1 ppm Chlorine

<b>Volume of Water</b>							
<b>% Available Chlorine</b>	<b>400 gallons</b>	<b>1,000 gallons</b>	<b>5,000 gallons</b>	<b>10,000 gallons</b>	<b>20,000 gallons</b>	<b>50,000 gallons</b>	<b>100,000 gallons</b>
5%	1.02 fl oz	2.56 fl oz	12.8 fl oz	1.60 pts	1.60 qts	1.00 gal	2.00 gal
10%	0.51 fl oz	1.28 fl oz	6.40 fl oz	12.8 fl oz	1.60 pts	2.00 qts	1.00 gal
12%	0.43 fl oz	1.07 fl oz	5.33 fl oz	10.7 fl oz	1.33 pts	1.67 qts	3.33 qts
35%	0.15 oz	0.38 oz	1.91 oz	3.82 oz	7.63 oz	1.19 lbs	2.38 lbs
60%	0.09 oz	0.22 oz	1.11 oz	2.23 oz	4.45 oz	11.1 oz	1.39 lbs
65%	0.08 oz	0.21 oz	1.03 oz	2.05 oz	4.11 oz	10.3 oz	1.28 lbs
90%	0.06 oz	0.15 oz	0.74 oz	1.48 oz	2.97 oz	7.42 oz	14.8 oz
100%	0.05 oz	0.13 oz	0.67 oz	1.34 oz	2.67 oz	6.68 oz	13.4 oz

Table B  
30 ppm Shock Table for Algae Removal

<b>Volume of Water</b>							
<b>% Available Chlorine</b>	<b>400 gallons</b>	<b>1,000 gallons</b>	<b>5,000 gallons</b>	<b>10,000 gallons</b>	<b>20,000 gallons</b>	<b>50,000 gallons</b>	<b>100,000 gallons</b>
5%	1.92 pts	2.40 qts	3.00 gal	6.00 gal	12.0 gal	30.0 gal	60.0 gal
10%	15.4 fl oz	1.20 qts	1.50 gal	3.00 gal	6.00 gal	15.0 gal	30.0 gal
12%	12.8 fl oz	1.0 qts	1.25 gal	2.50 gal	5.00 gal	12.5 gal	25.0 gal
35%	4.58 oz	11.4 oz	3.58 lbs	7.15 lbs	14.3 lbs	35.8 lbs	71.5 lbs
60%	2.67 oz	6.68 oz	2.09 lbs	4.17 lbs	8.35 lbs	20.9 lbs	41.7 lbs
65%	2.47 oz	6.17 oz	1.93 lbs	3.85 lbs	7.70 lbs	19.3 lbs	38.5 lbs
90%	1.78 oz	4.45 oz	1.39 lbs	2.78 lbs	5.56 lbs	13.9 lbs	27.8 lbs
100%	1.60 oz	4.01 oz	1.25 lbs	2.50 lbs	5.01 lbs	12.5 lbs	25.0 lbs

Table C  
To Decrease Free Chlorine Using Sodium Sulfite

<b>Volume of Water</b>							
<b>Desired decrease in ppm</b>	<b>400 gallons</b>	<b>1,000 gallons</b>	<b>5,000 gallons</b>	<b>10,000 gallons</b>	<b>20,000 gallons</b>	<b>50,000 gallons</b>	<b>100,000 gallons</b>
1 ppm	0.09 oz	0.24 oz	1.19 oz	2.37 oz	4.75 oz	11.9 oz	1.48 lbs
2 ppm	0.19 oz	0.47 oz	2.37 oz	4.75 oz	9.49 oz	1.48 lbs	2.97 lbs
3 ppm	0.28 oz	0.71 oz	3.56 oz	7.12 oz	14.2 oz	2.23 lbs	4.45 lbs
4 ppm	0.38 oz	0.95 oz	4.75 oz	9.49 oz	1.19 lbs	2.97 lbs	5.93 lbs
5 ppm	0.47 oz	1.19 oz	5.93 oz	11.9 oz	1.48 lbs	3.71 lbs	7.42 lbs
10 ppm	0.95 oz	2.37 oz	11.9 oz	1.48 lbs	2.97 lbs	7.42 lbs	14.8 lbs
15 ppm	1.42 oz	3.56 oz	1.11 lbs	2.23 lbs	4.45 lbs	11.1 lbs	22.3 lbs
20 ppm	1.90 oz	4.75 oz	1.48 lbs	2.97 lbs	5.93 lbs	14.8 lbs	29.7 lbs
30 ppm	2.85 oz	7.12 oz	2.23 lbs	4.45 lbs	8.90 lbs	22.3 lbs	44.5 lbs
50 ppm	4.75 oz	11.9 oz	3.71 lbs	7.42 lbs	14.8 lbs	37.1 lbs	74.2 lbs

Table D  
To Increase pH Using Soda Ash (Sodium Carbonate, 100%)  
with Taylor Base Demand Procedure

<b>Volume of Water</b>							
<b>Demand Reagent</b>	<b>400 gallons</b>	<b>1,000 gallons</b>	<b>5,000 gallons</b>	<b>10,000 gallons</b>	<b>20,000 gallons</b>	<b>50,000 gallons</b>	<b>100,000 gallons</b>
1 drop	0.21 oz	0.51 oz	2.56 oz	5.13 oz	10.3 oz	1.60 lbs	3.20 lbs
2 drops	0.41 oz	1.03 oz	5.13 oz	10.3 oz	1.28 lbs	3.20 lbs	6.41 lbs
3 drops	0.62 oz	1.54 oz	7.69 oz	15.4 oz	1.92 lbs	4.81 lbs	9.61 lbs
4 drops	0.82 oz	2.05 oz	10.3 oz	1.28 lbs	2.5 lbs	6.41 lbs	12.8 lbs
5 drops	1.03 oz	2.56 oz	12.8 oz	1.60 lbs	3.20 lbs	8.01 lbs	16.0 lbs
6 drops	1.23 oz	3.08 oz	15.4 oz	1.92 lbs	3.85 lbs	9.61 lbs	19.2 lbs
7 drops	1.44 oz	3.59 oz	1.12 lbs	2.24 lbs	4.49 lbs	11.2 lbs	22.4 lbs
8 drops	1.64 oz	4.10 oz	1.28 lbs	2.56 lbs	5.13 lbs	12.8 lbs	25.6 lbs
9 drops	1.85 oz	4.61 oz	1.44 lbs	2.88 lbs	5.77 lbs	14.4 lbs	28.8 lbs
10 drops	2.05 oz	5.13 oz	1.60 lbs	3.20 lbs	6.4 lbs	16.0 lbs	32.0 lbs

Table E  
To Decrease pH Using Muriatic Acid (20° Baumé/31.45% HCl)  
with Taylor Acid Demand Procedure

<b>Volume of Water</b>							
<b>Demand Reagent</b>	<b>400 gallons</b>	<b>1,000 gallons</b>	<b>5,000 gallons</b>	<b>10,000 gallons</b>	<b>20,000 gallons</b>	<b>50,000 gallons</b>	<b>100,000 gallons</b>
1 drop	0.37 fl oz	0.92 fl oz	4.58 fl oz	9.16 fl oz	1.15 pts	1.43 qts	2.86 qts
2 drops	0.73 fl oz	1.83 fl oz	9.16 fl oz	1.15 pts	1.15 qts	2.86 qts	1.43 gal
3 drops	1.10 fl oz	2.75 fl oz	13.7 fl oz	1.72 pts	1.72 qts	1.07 gal	2.15 gal
4 drops	1.47 fl oz	3.67 fl oz	1.15 pts	1.15 qts	2.29 qts	1.43 gal	2.86 gal
5 drops	1.83 fl oz	4.58 fl oz	1.43 pts	1.43 qts	2.86 qts	1.79 gal	3.58 gal
6 drops	2.20 fl oz	5.50 fl oz	1.72 pts	1.72 qts	3.44 qts	2.15 gal	4.30 gal
7 drops	2.57 fl oz	6.41 fl oz	1.00 qts	2.00 qts	1.00 gal	2.51 gal	5.01 gal
8 drops	2.93 fl oz	7.33 fl oz	1.15 qts	2.29 qts	1.15 gal	2.86 gal	5.73 gal
9 drops	3.30 fl oz	8.25 fl oz	1.29 qts	2.58 qts	1.29 gal	3.22 gal	6.44 gal
10 drops	3.67 fl oz	9.16 fl oz	1.43 qts	2.86 qts	1.43 gal	3.58 gal	7.16 gal

Table F  
To Decrease pH Using Dry Acid (Sodium Bisulfate, 93.2%)  
with Taylor Acid Demand Procedure

<b>Volume of Water</b>							
<b>Demand Reagent</b>	<b>400 gallons</b>	<b>1,000 gallons</b>	<b>5,000 gallons</b>	<b>10,000 gallons</b>	<b>20,000 gallons</b>	<b>50,000 gallons</b>	<b>100,000 gallons</b>
1 drop	0.49 oz	1.23 oz	6.16 oz	12.3 oz	1.54 lbs	3.85 lbs	7.70 lbs
2 drops	0.99 oz	2.46 oz	12.3 oz	1.54 lbs	3.08 lbs	7.70 lbs	15.5 lbs
3 drops	1.48 oz	3.70 oz	1.16 lbs	2.31 lbs	4.62 lbs	11.6 lbs	23.1 lbs
4 drops	1.97 oz	4.93 oz	1.54 lbs	3.08 lbs	6.16 lbs	15.4 lbs	30.5 lbs
5 drops	2.46 oz	6.16 oz	1.93 lbs	3.85 lbs	7.70 lbs	19.3 lbs	38.5 lbs
6 drops	2.96 oz	7.39 oz	2.31 lbs	4.62 lbs	9.24 lbs	23.1 lbs	46.2 lbs
7 drops	3.45 oz	8.63 oz	2.70 lbs	5.39 lbs	10.8 lbs	27.0 lbs	53.9 lbs
8 drops	3.94 oz	9.86 oz	3.08 lbs	6.16 lbs	12.3 lbs	30.8 lbs	61.6 lbs
9 drops	4.44 oz	11.1 oz	3.47 lbs	6.93 lbs	13.9 lbs	34.7 lbs	69.3 lbs
10 drops	4.93 oz	12.3 oz	3.85 lbs	7.70 lbs	15.4 lbs	38.5 lbs	77.0 lbs

Table G  
To Increase Alkalinity Using Baking Soda (Sodium Bicarbonate, 100%)

<b>Volume of Water</b>							
<b>Desired increase</b>	<b>400 gallons</b>	<b>1,000 gallons</b>	<b>5,000 gallons</b>	<b>10,000 gallons</b>	<b>20,000 gallons</b>	<b>50,000 gallons</b>	<b>100,000 gallons</b>
10 ppm	0.90 oz	2.24 oz	11.2 oz	1.40 lbs	2.80 lbs	7.00 lbs	14.0 lbs
20 ppm	1.79 oz	4.48 oz	1.40 lbs	2.80 lbs	5.60 lbs	14.0 lbs	28.0 lbs
30 ppm	2.69 oz	6.72 oz	2.10 lbs	4.20 lbs	8.41 lbs	21.0 lbs	42.0 lbs
40 ppm	3.59 oz	8.97 oz	2.80 lbs	5.60 lbs	11.2 lbs	28.0 lbs	56.0 lbs
50 ppm	4.48 oz	11.2 oz	3.50 lbs	7.00 lbs	14.0 lbs	35.0 lbs	70.0 lbs
60 ppm	5.38 oz	13.4 oz	4.20 lbs	8.41 lbs	16.8 lbs	42.0 lbs	84.1 lbs
70 ppm	6.28 oz	15.7 oz	4.90 lbs	9.81 lbs	19.6 lbs	49.0 lbs	98.1 lbs
80 ppm	7.17 oz	1.12 lbs	5.60 lbs	11.2 lbs	22.4 lbs	56.0 lbs	112 lbs
90 ppm	8.07 oz	1.26 lbs	6.30 lbs	12.6 lbs	25.2 lbs	63.0 lbs	126 lbs
100 ppm	8.97 oz	1.40 lbs	7.00 lbs	14.0 lbs	28.0 lbs	70.0 lbs	140 lbs

Table H  
To Decrease Alkalinity Using Dry Acid (Sodium Bisulfate, 93.2%)

<b>Volume of Water</b>							
<b>Desired decrease</b>	<b>400 gallons</b>	<b>1,000 gallons</b>	<b>5,000 gallons</b>	<b>10,000 gallons</b>	<b>20,000 gallons</b>	<b>50,000 gallons</b>	<b>100,000 gallons</b>
10 ppm	1.37 oz	3.44 oz	1.07 lbs	2.15 lbs	4.30 lbs	10.7 lbs	21.5 lbs
20 ppm	2.75 oz	6.87 oz	2.15 lbs	4.30 lbs	8.59 lbs	21.5 lbs	43.0 lbs
30 ppm	4.12 oz	10.3 oz	3.22 lbs	6.45 lbs	12.9 lbs	32.2 lbs	64.5 lbs
40 ppm	5.50 oz	13.7 oz	4.30 lbs	8.59 lbs	17.2 lbs	43.0 lbs	85.9 lbs
50 ppm	6.87 oz	1.07 lbs	5.37 lbs	10.7 lbs	21.5 lbs	53.7 lbs	107 lbs
60 ppm	8.25 oz	1.29 lbs	6.45 lbs	12.9 lbs	25.8 lbs	64.5 lbs	129 lbs
70 ppm	9.62 oz	1.50 lbs	7.52 lbs	15.0 lbs	30.1 lbs	75.2 lbs	150 lbs
80 ppm	11.0 oz	1.72 lbs	8.59 lbs	17.2 lbs	34.4 lbs	85.9 lbs	172 lbs
90 ppm	12.4 oz	1.93 lbs	9.67 lbs	19.3 lbs	38.7 lbs	96.7 lbs	193 lbs
100 ppm	13.7 oz	2.15 lbs	10.7 lbs	21.5 lbs	43.0 lbs	107 lbs	215 lbs

Table I  
To Decrease Alkalinity Using Muriatic Acid (20° Baumé / 31.45%)

<b>Volume of Water</b>							
<b>Desired decrease</b>	<b>400 gallons</b>	<b>1,000 gallons</b>	<b>5,000 gallons</b>	<b>10,000 gallons</b>	<b>20,000 gallons</b>	<b>50,000 gallons</b>	<b>100,000 gallons</b>
10 ppm	1.02 fl oz	2.56 fl oz	12.8 fl oz	1.60 pts	1.60 qts	3.99 qts	2.00 gal
20 ppm	2.04 fl oz	5.11 fl oz	1.60 pts	1.60 qts	3.20 qts	2.00 gal	3.99 gal
30 ppm	3.07 fl oz	7.67 fl oz	1.20 qts	2.40 qts	1.20 gal	3.00 gal	5.99 gal
40 ppm	4.09 fl oz	10.2 fl oz	1.60 qts	3.20 qts	1.60 gal	3.99 gal	7.99 gal
50 ppm	5.11 fl oz	12.8 fl oz	2.00 qts	3.99 gal	2.00 gal	4.99 gal	9.98 gal
60 ppm	6.13 fl oz	15.3 fl oz	2.40 qts	1.20 gal	2.40 gal	5.99 gal	12.0 gal
70 ppm	7.16 fl oz	1.12 pts	2.80 qts	1.40 gal	2.80 gal	6.99 gal	14.0 gal
80 ppm	8.18 fl oz	1.28 pts	3.20 qts	1.60 gal	3.20 gal	7.99 gal	16.0 gal
90 ppm	9.20 fl oz	1.44 pts	3.59 qts	1.80 gal	3.59 gal	8.99 gal	18.0 gal
100 ppm	10.2 fl oz	1.60 pts	3.99 qts	2.00 gal	3.99 gal	9.98 gal	20.0 gal

Table J  
To Increase Calcium Hardness Using Calcium Chloride (77%)

<b>Volume of Water</b>							
<b>Desired increase</b>	<b>400 gallons</b>	<b>1,000 gallons</b>	<b>5,000 gallons</b>	<b>10,000 gallons</b>	<b>20,000 gallons</b>	<b>50,000 gallons</b>	<b>100,000 gallons</b>
10 ppm	0.77 oz	1.92 oz	9.61 oz	1.20 lbs	2.40 lbs	6.01 lbs	12.0 lbs
20 ppm	1.54 oz	3.85 oz	1.20 lbs	2.40 lbs	4.81 lbs	12.0 lbs	24.0 lbs
30 ppm	2.31 oz	5.77 oz	1.80 lbs	3.61 lbs	7.21 lbs	18.0 lbs	36.1 lbs
40 ppm	3.08 oz	7.69 oz	2.40 lbs	4.81 lbs	9.61 lbs	24.0 lbs	48.1 lbs
50 ppm	3.85 oz	9.61 oz	3.00 lbs	6.01 lbs	12.0 lbs	30.0 lbs	60.1 lbs
60 ppm	4.62 oz	11.5 oz	3.61 lbs	7.21 lbs	14.4 lbs	36.1 lbs	72.1 lbs
70 ppm	5.38 oz	13.5 oz	4.21 lbs	8.41 lbs	16.8 lbs	42.1 lbs	84.1 lbs
80 ppm	6.15 oz	15.4 oz	4.81 lbs	9.61 lbs	19.2 lbs	48.1 lbs	96.2 lbs
90 ppm	6.92 oz	1.08 lbs	5.41 lbs	10.8 lbs	21.6 lbs	54.1 lbs	108 lbs
100 ppm	7.69 oz	1.20 lbs	6.01 lbs	12.0 lbs	24.0 lbs	60.1 lbs	120 lbs

## **B. ORDER OF APPLICATION**

1. Chemicals or sanitizers for water balance adjustments should be added in the following sequence:
  - (a) Free available chlorine (FAC)
  - (b) Total alkalinity
  - (c) pH
  - (d) Calcium Hardness
  - (e) Cyanuric Acid (outdoor pools)
  
2. Adding Chemicals:
  - (a) Add large amounts gradually in thirds over a two-hour period.
  - (b) Add directly into the pool or spa when no swimmers are present and time is sufficient to permit even distribution of the chemicals.
  - (c) Add granular chlorine or soda ash solution directly to the pool, but separately. Always mix chemicals into plastic containers that have been filled with water first.



## WATER QUALITY PROBLEMS

### Calculate for 20,000 Gallons:

Free CL	2.0 ppm
Total CL	3.0 ppm
PH	7.0 ppm
Total Alk.	50 ppm
Calcium Hardness	100 ppm
Temperature	80 °F

What is the ppm for breakpoint chlorination? \_\_\_\_\_  
Use how much calcium hypochlorite 65% to shock pool? \_\_\_\_\_  
How much for a 30 ppm shock for algae removal? \_\_\_\_\_  
How much sodium bicarbonate to raise to 100 ppm? \_\_\_\_\_  
pH 4-drop test; how much soda ash? \_\_\_\_\_  
Is water under or over saturated? \_\_\_\_\_

### Calculate for 50,000 Gallons:

Free CL	1.0 ppm
Total CL	3.0 ppm
PH	8.0 ppm
Total Alk.	180 ppm
Calcium Hardness	500 ppm
Temperature	80 °F

What is the ppm for breakpoint chlorination? \_\_\_\_\_  
Use how much calcium hypochlorite 65% to shock pool? \_\_\_\_\_  
How much for a 30 ppm shock for algae removal? \_\_\_\_\_  
How much muriatic acid to lower to 100 ppm? \_\_\_\_\_  
pH 4-drop test; how much muriatic acid? \_\_\_\_\_  
Is water under or over saturated? \_\_\_\_\_

## SECTION 6 — SPAS

A casual attitude regarding maintenance and safety standards for spas can quickly produce an unhealthy and unsafe environment. Six bathers in a 7-foot, 600-gallon spa are equivalent to 410 bathers in a 25' x 50' x 4' swimming pool. This comparison indicates the dramatic effect bather load has on spas and emphasizes the need for paying strict attention to care and maintenance guidelines. Refer to page 5-7 for chemical standards.

Spas require a significant chlorine demand because of the high turnover rate, higher temperatures, higher soil loads, and higher bather loads. It is more difficult to maintain sanitization levels in a spa or hot tub than in a swimming pool. Disinfectants (chlorine or bromine) are consumed at an accelerated rate during periods of use; therefore, the operator must closely monitor disinfectant levels. In addition the operator must:

1. Enforce rules and regulations through proper signs.
2. Ensure the water does not exceed 105°F.
3. Ensure that the main drain is secured and clearly visible.
4. Test and keep records as per code.
5. Drain the spa after heavy use (especially if the tub is 2,000 gallons or less). The required schedule for draining is two (2) times a month if the spa is sparsely used.
6. Drain the spa and clean it out whenever in doubt.



## SECTION 7 — CHEMICAL SAFETY

When dealing with swimming pool and spa chemicals, certain precautions must be taken concerning their usage, storage and handling to avoid a potentially dangerous situation. Following is a list of general safety guidelines. This list is by no means complete. Remember to always use common sense and keep safety in mind.

### DO

- ✓ Always follow label directions.
- ✓ Store chemicals in a cool and dry place.
- ✓ Always use a separate, clean measuring cup for each chemical.
- ✓ Always keep containers tightly sealed.
- ✓ Always add chemicals to water - slowly. Never add water to chemicals.
- ✓ Keep chemicals out of reach of children.
- ✓ Always use caution when transporting chemicals.
- ✓ Always store pool chemicals separately from other chemicals (fertilizers, insecticides, cleaners, solvents, etc.)
- ✓ Always carry and store liquid (muriatic) acid or liquid chlorine bottles upright. The vented caps can cause leakage.
- ✓ Protect eyes and skin.

### DON'T

- ✗ Mix chemicals of any kind together.
- ✗ Add more than one pint of muriatic acid per 10,000 gallons of pool water at any one time.
- ✗ Smoke around dry chlorine or any pool chemicals
- ✗ Inhale fumes or allow chemicals to contact eyes, nose or mouth.
- ✗ Store incompatible pool chemicals together.
- ✗ Add calcium chloride the same day as sodium bicarbonate.
- ✗ Add large amounts of chemicals at one time (add in thirds over extended period of time).
- ✗ Add chemicals to the pool with swimmers present.
- ✗ Add chelating/sequestering agents the same day as polymeric clarifiers.



## SECTION 8 — TROUBLESHOOTING

### A. IDENTIFYING PROBLEMS

1. Test and analyze the water.
2. Use your senses.
  - ✓ Touch
  - ✓ Smell
  - ✓ Sight
  - ✓ Sound
3. Check pressure gauges and flow meters.
4. Eliminate the possibilities one by one. Identify and correct the problem.
5. Call in a professional if problem is beyond your scope of expertise.

### B. BASIC CIRCULATION SYSTEM PROBLEMS

The following will cover basic troubleshooting of a swimming pool/spa circulation system.

#### 1. Pressure Leaks

When a pool pump has to be primed each time it is turned on, but the pump operates without air problems, the system has a pressure side air leak. To find the leak, look for signs of water. Some of the common causes include:

- ◆ Defective filter tank "O" ring or gasket
- ◆ Defective air relief or pressure gauge
- ◆ Pin hole in piping or defective connection

- ◆ Defective or worn backwash valve stem "O" rings
- ◆ Worn pump seal in booster pump or defective hose
- ◆ Split or pin hole in chlorinator hose
- ◆ Improperly sealed filter tank or pin hole in tank

If the cause of the problem cannot be found, install a check valve on the suction side of the pump. This will eliminate the need for daily pump priming.

## 2. Suction Leaks

The most apparent sign of a suction leak (suction side of pump) is air bubbles continually shooting out the return lines. Some of the common causes include:

- ◆ Worn pump lid "O" ring or need for lubrication
- ◆ Cracked/warped pump lid or housing
- ◆ Pump seal
- ◆ Loose nut on gate valve or ball valve
- ◆ Worn shaft "O" ring on Jandy or Ortega valve
- ◆ Deformed suction gasket (if applicable)
- ◆ Chlorinator suction hose pinhole or split
- ◆ Pump drain plug loose or stripped
- ◆ Loose or poor threaded connection at inlet
- ◆ Pin hole in suction pipe
- ◆ Low water level

### 3. Clogged Skimmer Or Pump Basket

A clogged skimmer or pump basket will generally cause pool suction and low filter pressure. These areas should be checked first if you are experiencing water flow problems.

### 4. D.E. In Filter Grids

If D.E. filter grids are full of D.E., the most common causes include:

- ◆ Filter is plumbed backwards
- ◆ D.E. was added while backwash valve was in the backwash position

### 5. Sudden Filter Pressure Drop

A sudden drop in filter pressure is generally caused by the following:

- ◆ Clogged impeller
- ◆ Broken impeller
- ◆ Suction leak
- ◆ Clogged pump basket
- ◆ Clogged skimmer basket
- ◆ Clogged suction line
- ◆ Pump motor inoperable
- ◆ Partially closed valve

### 6. Impeller Sizing

Never upsize an impeller. Putting an impeller with a higher horsepower than the stated motor horsepower will place an excessive load on the motor. If your pump has too much flow with the current impeller, you can downsize the impeller one size. This generally will solve the problem without damaging the motor.



## 7. Filter Pressure

Under most circumstances, the filter should not operate at a pressure in excess of 25 pounds. A high reading usually indicates that there is a need for a complete manual cleaning or that there is a malfunction in the system.

## 8. Troubleshooting Tip

The pool designer/engineer sized the filter and pump for optimum efficiency. Never replace existing filter without considering the pool and pump size. Improper sizing of the filter or pump can create filtration and circulation problems. In addition, remember the following:

- ◆ Don't oversize the pump
- ◆ Don't undersize the pipes or filter

## 9. Filtration Problems

Most filtration problems occur because of the following:

- ◆ Air in the system
- ◆ Not using the proper type and/or amount of sand
- ◆ Not using the proper amount of D.E.
- ◆ Improper backwashing/cleaning
- ◆ Pump and/or filter not properly sized
- ◆ Mechanical problems with filter and/or backwash valve (damaged components)
- ◆ Improper water balance
- ◆ Particle size of suspended materials

## 10. Using Gauges to Identify Problems

	Vacuum Gauge	Influent Gauge (P-1)	Effluent Gauge (P-2)	Trouble Indicated
1	Down from Start-up Reading	Up from Start-up Reading	Down from Start-up Reading	Filter Require Cleaning
2	Up from Start-up Reading	Down from Start-up Reading	Down from Start-up Reading	Blocked Suction or Clogged Strainer
3	Down from Start-up Reading	No Change from Start-up Reading	No Change from Start-up Reading	Defective Pump Seal, Clogged Impeller or Air Suction
4	Down from Start-up Reading	Up from Start-up Reading	Up from Start-up Reading	Restriction in Pool, Return Line, or Partial Closed Valve
5	Up from Start-up Reading	Up from Start-up Reading	Up from Start-up Reading	Increased Flow Due to Pump Cleaning Itself, or the Opening of a Partially Closed Valve

### C. VENTILATION

1. What's the first sign that your facility may have indoor air quality problems? It will probably be health complaints from your patrons. The following are common symptoms from poor ventilation of indoor pools.
  - ◆ Chronic respiratory problems such as sinus congestion, nosebleeds, asthma and sore throats
  - ◆ Drowsiness, fatigue, irritability, headaches and inability to concentrate
  - ◆ Persistent viral and bacterial infections
  - ◆ Skin rashes, dry skin, hypersensitivity diseases, and other dermatological problems
2. It is important to record all complaints made by patrons or staff related to air quality.

3. While there are numerous steps to take to ensure proper indoor air quality, the following basic checklist includes the most important provisions to maintaining optimum air quality:

- ✓ Maintain air temperature 2 °F to 7 °F above pool water temperature
- ✓ Cover the spa/pool when not in use
- ✓ Maintain relative humidity between 40 and 50 percent
- ✓ Ventilate at a rate of 0.5 cfm per square foot of facility area, plus 20 cfm for each anticipated bather or spectator
- ✓ Ensure eight complete air exchanges per hour
- ✓ Distribute air from low to high and across the surface of the pool
- ✓ Cross ventilate - introduce and exhaust air on all four sides of the pool
- ✓ Comply with OSHA's "Permissible Exposure Limits" and the American Conference of Governmental Industrial Hygienists' "Threshold Limit Values" exposure standards
- ✓ Maintain CO<sub>2</sub> levels below 0.1 percent or 1,000 ppm
- ✓ Sample and analyze natatorium air quality
- ✓ Make sure the natatorium has a positive pressure to allow pollutants to travel from positive to negative pressure areas
- ✓ Design to avoid drafts, thermocline formation or temperature gradients

## **SECTION 9 — PREVENTATIVE MAINTENANCE**

Preventative maintenance is the key to efficient, economical operation of a pool facility. Like the old adage says, "Pay me now or pay me later", a preventative maintenance program equals increased operational savings.

### **A. PUMP AND MOTOR**

The pump was sized to the filter and pool for optimum efficiency by the pool designer/engineer. Never increase the horsepower of your pump without considering the size of the filter and pipes. An oversized pump will create pump and filtration problems.

#### **1. Motors**

The electric motor that powers the pump is considered an electric appliance and must be protected from foreign matter, water, and the weather. The motor should be shaded from the sun and have good cross ventilation; the motor is air-cooled and any material blocking the air suction vents can cause the motor to overheat. In addition, any water from equipment leaks or rain can be drawn into the motor and cause it to short out. Whenever a motor has become wet, allow it to dry completely before running it again. If a motor is exposed to direct sunlight and the elements, a vented motor cover should be used for protection.

#### **2. Pumps**

The hair and lint strainer (pump basket) should be checked daily and cleaned/emptied as required. After cleaning the strainer, inspect the pump lid for deformities or cracks. Also inspect the lid "O" ring to be sure it is still round and pliable. If there is a gasket, make sure it is not torn or stretched. Replace the gasket if necessary.

Place a light coat of Teflon-based lubricant on the pump lid "O" ring or gasket.

Note: Remember, the skimmer baskets will normally trap most leaves and debris. If your pump basket is continually full, check your skimmer baskets for cracks and tears.

Inspect the equipment area daily for signs of leakage. Replace the pump seal as required.

When priming the pump, do not let the pump run for more than 30-45 seconds; operating it without water will damage the water-lubricated pump seal. Repeat procedure until it is fully primed.

When replacing the pump seal, never lubricate the white ceramic surface and the black molded graphite impregnated plastic surface of the seal.

## **B. FILTERS**

Most filters require little maintenance other than a normal manual cleaning, purging of air and a thorough visual inspection. Inspect the tank "O" ring or gasket and lightly lubricate with a Teflon-based or pure silicone-based lubricant.

The filter grids, cartridge or sand bed (depending on the filter) should be visually inspected for tears, broken parts, scale formation, deformities or contamination. Replace as necessary. Clean the outside of the tank as required.

## **C. GAUGES AND FLOW METERS**

Pressure gauges and flow meters are relatively trouble-free.

- ◆ Gauges should register "Zero" when the pump is shut off.
- ◆ Flow meters should be kept clean. Should the meter fail to read, make sure the pilot tube is free of obstructions.

## **D. POOL LIGHTS**

All swimming pool light units are designed for easy maintenance. They can be quickly removed from the light niche and generally have 8 to 10 feet of extra cord so that they can be brought up onto the deck for bulb replacement. With all new style wet niche lights, the pool does not have to be partially drained to service the light.

Because a pool light is water cooled, NEVER operate a pool light unless it is submerged. To do so could result in an explosion of the lens, a broken bulb and a damaged gasket. ALWAYS shut off the circuit breaker prior to working on a pool light. ALWAYS make sure the new bulb is the same style, voltage and wattage as the old bulb. ALWAYS replace the old light gasket with a new light gasket. This must be done every time the light is opened up. ALWAYS apply a thin coat of Teflon based lubricant on the sealing surfaces of the light gasket. If the unit is sealed by screws, lubricate those too.

## **E. BACKWASH VALVES**

Normal backwash valve (rotary multiport valve or a push-pull type valve) preventative maintenance consists of a visual inspection for leaks or cracks, and "O" ring, puck or gasket replacement.

### **1. Rotary Multiport Valve Maintenance**

Most multiport valves require little maintenance. However, periodically you should check the following:

- ◆ Make sure the handle turns freely. If not, the Teflon washer on the rotor could be cracked or deformed and must be replaced. Also check the internal valve seat or spider gasket for an accumulation of dirt or sand.
- ◆ If water is present in the sight glass, also check internal valve seat or spider gasket, Teflon washer and the spring.
- ◆ If water is present in the cover, the rotor "O" rings are worn.

- ◆ When changing the handle position on a backwash valve, the pump must always be off. Additionally, if the pool needs to be drained, use a submersible pump. This will prevent possible pump or filter damage.
- ◆ The rotor "O" rings should be lubricated with a Teflon-based lubricant. When reassembling a rotary multiport valve, make sure the position of the rotor matches the original position of the handle.

## 2. Push-Pull Valve Maintenance

- ◆ Push-pull type valves require only occasional maintenance. Signs that attention is needed are D.E. or sand returning to the pool during normal operation, leaking from around handle or very difficult operation of the valve. All of these are indicators that the "O" rings or piston pucks require replacement.
- ◆ There are four or five "O" rings/pucks depending on the brand and model of the valve. Generally, one "O" ring seals the top cover and valve body. A small "O" ring seals the shaft where it passes through the top cover. There are usually two "O" ring or pucks on the piston.
- ◆ The valve "O" rings or piston pucks should be lubricated on a regular basis. This will ensure proper operation and longer "O" ring life. Always use a silicone-based lubricant. Whenever the valve is disassembled, the pucks and shaft should be checked for wear.
- ◆ Important: Never vacuum the pool with the valve in the backwash position.

## F. CHLORINATORS/BROMINATORS

Because there are many brands and models of chlorinators/brominators available, each general type will be addressed.

### 1. Erosion and Suction-Pressure (Cross Pump) Feeders

Normal erosion feeder (Hayward, Rainbow, etc.) and suction-pressure feeder (Watermatic, etc.) preventative maintenance includes:

- ◆ Inspect tubing and connections
- ◆ Inspect/clean check valves, flow indicators and screens, measuring cups
- ◆ Lid "O" ring (if applicable) — lubricate with a silicone-based lubricant
- ◆ Inspect housing for cracks or deformities — clean unit if necessary

### 2. Peristaltic and Diaphragm Feeder Pumps

Normal peristaltic (Blue White, Stenner, etc.) and diaphragm (Pulsatron, Chemtech, LMI, etc.) feeder pump preventative maintenance includes:

- ◆ Inspect physical operating condition of the pump — abnormal sounds, excessive vibration, low flow, cracked or deformed components.
- ◆ Repeated short-term deterioration of valve seats and balls, pumphead, "O" rings, etc. indicate the need to review suitability of wetted materials selected for the chemical in use.
- ◆ Inspect tubing, foot valve and injectors for leaks and obstructions — clean or replace as required.



- ◆ Flush tubing and pumphead assembly periodically with fresh water or other suitable neutralizing solutions.
- ◆ If sodium hypochlorite is utilized as the primary sanitizer, the chemical should be pumped full-strength to prevent salt-related deposits.

## **G. CONTROLLERS**

Normal controller preventative maintenance includes:

- ◆ Unit calibration
- ◆ Cleaning flow/sample cell and tubing
- ◆ Cleaning ORP/pH probes (First, soapy water and then muriatic acid)
- ◆ Inspect/clean unit

## **H. SKIMMERS, GRATES AND INLETS**

Normal skimmer, main drain grate and inlet fitting/cover preventative maintenance includes:

- ◆ Inspect drain grates, inlet fittings and covers for breakage. Replace as required.
- ◆ Inspect skimmer body, cover and skimmer basket for cracks. Repair/replace as required.
- ◆ Inspect equalizer/float valve assembly and weir for proper operation. Replace as required.

## **I. HEATERS**

Normal heater preventative maintenance includes:

- ◆ Keep the heater area free of debris, especially the top. Never store combustible materials near the heater.
- ◆ Inspect and clean vent piping if necessary.

- ◆ Use a mirror to inspect the burner and heat exchanger for soot accumulation. Clean as required.
- ◆ Inspect the pilot and burner for full, clean flames.
- ◆ Maintain proper water balance. This will prevent many problems.

#### **J. DIVING BOARD, HAND RAILS, LADDERS & LIFEGUARD STANDS**

Normal diving board, handrail, ladder and lifeguard stand preventative maintenance includes:

- ◆ Inspection of bolts, treads, hand rails, fulcrum pads, etc. If corrosion is evident, repair/replace as required.
- ◆ Keep ladders and diving board treads free of accumulated debris.

#### **K. WATER BALANCE**

- ◆ Proper water balance ensures long equipment and vessel life. Add a sequestering agent to prevent scale and surface discoloration.
- ◆ Enzymes may be used to help prevent oil build-up and deposits, and provide extended filter runs.

#### **L. DECKING, COPING AND TILE**

The decking, coping and tile should be kept clean and free of debris. Use a tile cleaner as required and scrub the deck with a bleach and water solution (20 parts water to one part bleach) to prevent mold, mildew and bacterial growth.

## M. POOL WINTERIZING CHECKLIST

- \_\_\_\_\_ 1. Adjust chemical balance of pool water to recommended levels.
- \_\_\_\_\_ 2. Superchlorinate.
- \_\_\_\_\_ 3. Add an algaecide to prevent algae growth.
- \_\_\_\_\_ 4. Add sequestering or chelating agents to prevent mineral staining and scale build-up.
- \_\_\_\_\_ 5. Clean and vacuum the pool, because any debris left in the water will consume chlorine during the off season.
- \_\_\_\_\_ 6. Empty and store skimmer baskets and hair-and-lint traps for the winter.
- \_\_\_\_\_ 7. Backwash the filter thoroughly.
- \_\_\_\_\_ 8. Clean the filter media or elements.
- \_\_\_\_\_ 9. Drain sand filters. Remove cartridges or DE filter elements, inspect for tears or excessive wear and store for the winter.
- \_\_\_\_\_ 10. Lower the water level to below the skimmers and return lines. If needed, remove the remaining water from the recirculation lines using an air compressor or industrial type tank vacuum cleaner.
- \_\_\_\_\_ 11. Open all pump room valves and loosen the lid from the hair-and-lint skimmer. However, if the filter is below pool water level, close the valves leading from the pool to the filter.
- \_\_\_\_\_ 12. Grease all plugs and threads.
- \_\_\_\_\_ 13. Add a non-toxic antifreeze such as propylene glycol (1 part antifreeze diluted in 2 parts water) to the pipes to prevent freeze damage and possible bursting. Do not use automotive antifreeze.
- \_\_\_\_\_ 14. Plug skimmer or gutter lines. Winterize with antifreeze and expansion blocks. Secure skimmer lids to the deck to prevent their loss.
- \_\_\_\_\_ 15. Plug vacuum and return lines and the main drain.
- \_\_\_\_\_ 16. Make sure the hydrostatic relief valve is operational.
- \_\_\_\_\_ 17. Drain and protect recirculation pumps. If a pump and motor will be exposed to severe weather, disconnect, lubricate, perform seasonal maintenance, replace seals and store. Add antifreeze to help protect pumps and seals from any residual water left after draining.
- \_\_\_\_\_ 18. Clean surge pits or balancing tanks.
- \_\_\_\_\_ 19. If underwater wet-niche lights are exposed to the elements, remove them from their niches and lower them to the bottom of the pool.
- \_\_\_\_\_ 20. Disconnect all fuses and open circuit breakers.
- \_\_\_\_\_ 21. Drain pool water heater. Grease drain plugs and store for the winter.
- \_\_\_\_\_ 22. Turn off the heater gas supply, gas valves and pilot lights.
- \_\_\_\_\_ 23. Install the winter safety cover.
- \_\_\_\_\_ 24. Return any unopened chemical and empty storage containers to the distributor.
- \_\_\_\_\_ 25. Properly store opened chemicals in tightly sealed containers in a well-ventilated room. Dispose of test reagents, sanitizers and other chemicals that will lose their potency over the winter.
- \_\_\_\_\_ 26. Disconnect, clean and store the chlorinator, controllers and other chemical feed pumps. Store controller electrodes in liquid.
- \_\_\_\_\_ 27. Clean and protect gauges, flowmeters, thermometers and hygrometers.
- \_\_\_\_\_ 28. Store all deck furniture (chairs, lounges, tables, umbrellas). Identify and separate all furniture in need of repair.
- \_\_\_\_\_ 29. Remove deck equipment, hardware and non-permanent objects such as ladders, rails, slides, guard chairs, starting blocks, drinking fountains, disabled lifts, portable ramps, clocks, wires and rescue equipment to prevent vandalism. Store the items in a clearly marked, identifiable, weather-protected location. Cap all exposed deck anchors or sockets.
- \_\_\_\_\_ 30. Remove the diving boards. Store the boards indoors, upside down and flat so they will not warp.
- \_\_\_\_\_ 31. Open hose bibs and fill spouts.
- \_\_\_\_\_ 32. Turn off the water supply to restroom showers, sinks and toilets. Drain the pipes; add antifreeze. Remove any shower heads and drinking fountain handles.
- \_\_\_\_\_ 33. Have the phone company disconnect the pool telephone and discontinue service for the winter.
- \_\_\_\_\_ 34. Install a pool or deck alarm system.
- \_\_\_\_\_ 35. Inventory supplies and equipment. Make suggestions for preventive maintenance and repair, upgrading and needed equipment purchases.

## **N. COMMONLY OVERLOOKED ITEMS**

You should pay special attention to the following operational requirements. The code requires that you:

1. Test and record four (4) times per day:
  - (a) Free chlorine or bromine
  - (b) pH
  - (c) Turbidity
  - (d) Temperature (if heated-water facility)
2. Test and record once per day:
  - (a) Combined chlorine
  - (b) Turnover rate
3. Test and record weekly:
  - (a) Total alkalinity
  - (b) Calcium hardness
  - (c) Cyanuric acid (if used)
  - (d) Copper (if heated-water facility)
  - (e) Iron (if heated-water facility)
  - (f) Total dissolved solids (if heated-water facility)
4. Keep daily operation records:
  - (a) Record all testing and other pertinent information.
  - (b) Keep accessible for inspection and maintain records for a three-year period.
5. Properly label piping and valves.
6. Post the following signs:
  - (a) Bathing load limits (in pool area)
  - (b) Rules and precautions for patrons (in pool area)
  - (c) "No lifeguard or attendant on duty sign" (in pool area, at pools not open to the general public)
  - (d) Pool volume and turnover rate (in equipment area)
  - (e) "Pool chemicals" (on door of chemical storage room)
  - (f) Spa Health Caution Sign

7. Post pool license.
8. Post current inspection form (in a conspicuous place visible to all who use the facilities).
9. Post each lifeguard's life saving certificate (convenient point so as to be easily read by patrons).
10. Report all drownings and accidents requiring hospitalization to the Health Department immediately by telephone and in writing within seven (7) days.
11. Close pool if:
  - (a) Turbidity exists where you cannot see the main drain from the edge of the deck.
  - (b) Free available chlorine is less than 1.0 ppm; Bromine less than 2.0 ppm.
  - (c) pH is less than 7.2 or greater than 7.8.
  - (d) No lifeguard is on duty (pools open to general public).
  - (e) No safety equipment at pool side.
  - (f) Gaseous chlorine facilities are not in code compliance.
  - (g) Water temperature is over 105°F (Spas).
  - (h) Anti-vortex drain cover off or not secured.
12. Assure that all gauges are in good repair and are properly operating. Your pool must have the following meters and/or gauges:
  - (a) Influent (measures pressure coming into the filter)
  - (b) Effluent (measures pressure leaving the filter)
  - (c) Compound (tells whether or not the hair and lint strainer is clogged)
  - (d) Flowmeter (measures the gpm flow of water through the system)
13. Assure that spa water temperature is 105 °F or less and that patron warning regulations are posted.

14. Assure that the required life saving equipment is in place and accessible.
  - (a) For pools with 1,600 square feet of surface area you must have:
    - (1) Shepherd crook with 16 foot pole attached
    - (2) Two 15-18 inch ring buoys with attached 1/4 inch rope long enough to reach the length of the pool
  - (b) For pools with over 1,600 square feet of surface area and the above listed equipment is doubled and a backboard is required.
15. Make sure the effective barrier (fence is in good repair and has operable self-closing, self-latching gates).
16. Make sure that required depth markings are on the pool sidewalk and deck.
17. Assure that approved vacuum breakers are included at all hose connections.
18. Lock all gates and post "Pool Closed" signs when the pool is not open.
19. Ground fault interrupter type circuit breakers shall be provided for all outlets within 15' of the pool and those located in bath house and pump room.
20. Vacuum and brush at least once a week.

This listing is not intended to be all inclusive.



<b>Bathing Place Operation Record</b>						Week of:		
1. Facility Name:				Type of Facility:				
Address:				City:		Zip:		
2. Size: _____ gallons		Required Turnover: _____ gallons/min (MIN)						
	<b>Monday</b>	<b>Tuesday</b>	<b>Wednesday</b>	<b>Thursday</b>	<b>Friday</b>	<b>Saturday</b>	<b>Sunday</b>	
3. Safety Equipment Checked (time)								
4. Pool Clean / Vacuumed (time)								
5. Floors / Decks Disinfected (time)								
6. Number of Patrons (daily)								
7. Number of Accidents (daily)								
8. Number of Guards / Attendants (daily)								
9. Pool Hours (Open/Closed)								
<b>FILTER:</b>								
10. Backwashed (time)								
11. Gauge Readings (influent / effluent)								
12. Gallons Makeup Water Added								
13. Strainer Gauge Reading								
14. Flowmeter Reading (gpm) / temp (F)								
<b>CHEMICALS ADDED - Amount</b>								
15. Chlorine _____ Bromine _____								
16. Soda Ash								
17. Muriatic Acid								
18. Sodium Bicarbonate								
19. Calcium Chloride								
20. Cyanuric Acid (stabilizer)								
21. Other								
<b>REQUIRED TESTS - DAILY</b>		<b>Monday</b>	<b>Tuesday</b>	<b>Wednesday</b>	<b>Thursday</b>	<b>Friday</b>	<b>Saturday</b>	<b>Sunday</b>
22. Combined Chlorine (ppm - daily)								
<b>Enter: time / sanitizer reading / pH</b>		T S pH	T S pH	T S pH	T S pH	T S pH	T S pH	T S pH
23. First Test Series								
24. Second Test Series								
25. Third Test Series								
26. Fourth Test Series								
<b>Enter: time / turbidity / drain cover on</b>		T Tu DC	T Tu DC	T Tu DC	T Tu DC	T Tu DC	T Tu DC	T Tu DC
27. First Observation Series								
28. Second Observation Series								
29. Third Observation Series								
30. Fourth Observation Series								
<b>REQUIRED TESTS - WEEKLY MIN (recommend daily)</b>			<b>Tuesday</b>	<b>Wednesday</b>	<b>Thursday</b>	<b>Friday</b>	<b>Saturday</b>	<b>Sunday</b>
31. Total Alkalinity								
32. Calcium Hardness								
33. Water Balance Ph								
34. Cyanuric Acid (stabilizer)								
35. Copper								
36. Iron								
37. Total Dissolved Solids								
38. Pool Operator's Permit								
39. Pool Manager/Owner								
Signed:						Date:		

**Tulsa City-County Health Department — 5051 South 129<sup>th</sup> East Avenue Tulsa, OK 74134**  
**Phone: (918) 595-4200 — Fax: (918) 595-4359**

RETAIN COPY FOR THREE YEARS

**COPY BOTH SIDES**



## INSTRUCTIONS FOR FILLING OUT RECORD FORM

This form is filled out for each pool. Some of this information does not change so keep a blank form filled out for each pool to make copies from. Fill out all applicable blanks every day the facility is open or whenever maintenance is done. Keep a copy in the pump room and one in the file. Retain copies for a minimum of three years.

- Line 1: Under "Facility Name" designate the facility name, Facility type and address.  
(Example: Conan's Health Club - Men's Spa or Seabrook Club - East Pool)
- Line 2: Enter the size of the pool/spa in gallons and the minimum flow required for the type of pool (480 min/pool, 240/wading pool, 30/spa).
- Line 3: Time safety equipment is checked (usually at opening).
- Line 4: Time pool/spa is cleaned and/or vacuumed (usually at opening).
- Line 5: Time bathhouse floor and/or deck are cleaned and disinfected (usually at opening).
- Line 6: Operators estimate of the total number of persons using the pool/spa that day.
- Line 7: Number of accidents. For accidents involving death, drowning or hospitalization the Health Department must be called immediately and a written report sent within 7 days.
- Line 8: Number of certified lifeguards on duty during the time of maximum load.
- Line 9: Time pool/spa is opened and closed for use. Example: "10am/8pm".
- Line 10: Time the filter is backwashed.
- Line 11: Inlet and outlet (influent/effluent) gauge readings (prior to backwash)
- Line 12: Gallons of make-up water added.
- Line 13: Strainer/compound gauge reading.
- Line 14: Flowmeter reading and temperature of water.
- Line 15: Type and amount of sanitizer in use.
- Line 16-21 Amount of other chemicals added to the pool/spa.
- Line 22: Combined chlorine reading taken at closing each day. Max. = 0.2 ppm
- Line 23-26: Enter test readings 4 times per day. T = time, S= sanitizer, pH - pH
- Line 27-30: Enter test readings/observations 4 times per day. T = time  
Tu = Turbidity  
S = satisfactory,  
M = marginal for cloudy water but still able to see main drain;  
U = cannot see main drain  
DC = Main drain cover securely in place
- Line 31-37: Enter when run Total Alkalinity, Calcium hardness and Cyanuric Acid/stabilizer (required weekly - recommended daily).  
Copper, Iron, TDS weekly on spas only.
- Line 38: Name of person responsible for the operation of the pool/spa (Pool Operator's Permit)
- Line 39: Name of owner, manager or person in charge of the facility.

The form must be signed by one of the persons on Line 38 or 39.

### IMMINENT HAZARD ITEMS

#### Immediate Correction or Closure Required Summarily

- Turbidity: Main drain must be clearly visible
- Free Available Chlorine must be 1.0 ppm, Bromine 2.0 ppm.
- pH must be between 7.2 and 7.8
- Main Drain must be Secured



## Tulsa City-County Health Department PUBLIC BATHING PLACE PROGRAM - INSPECTION REPORT

Estab #:	Date:	Time:	<b>PURPOSE</b>	<b>ACTION</b>
Establishment:			Routine	None
Address:			Complaint	Warning
City & Zip:			Follow-up	Voluntary Close
			Other	Other (See Back)
			Close Owner	Suspend License
			Close-Fill In	Ticket Issued

Title 17 Chapter 12		Categories & Descriptions	Violation		REMARKS	
315	320					
<b>Pool, Spa Area</b>	7-2	Enclosure: Height, no gaps over 4", good repair: SC/SL gates	**	1		
		3-2 Lifeguard(s), CPR, 1st Aid Personnel; Certifications; "No Guard"	**	2		
	7-3, 13	3-3, 4, 6 Signs: Bathing load, diving, rules, chemicals, spa		3		
		3-1, 4 First Aid Kit available; Emergency telephone numbers posted		4		
		3-1 Ring buoys, Shepherd's crook, backboard; lifeline: telephone	**	5		
	7-1, 6	3-2 Decks, gutter, pool finish: Clean, good repair		6		
	7-4, 5, 14	Depth markers; stair stripes (pools); main drain contrasting color	**	7		
	7-14	3-2 Recirculation inlets: Adjusted properly, open		8		
	7-14	Outlets: Proper and secure	**	9		
	7-14	3-2 Skimmers: Weirs and baskets installed; clean and operating		10		
	7-4, 5, 11	3-2 Ladders, handrails, coping, etc. in good repair		11		
	<b>Circulation &amp; Disinfection</b>	7-4	3-2 App. Diving Board: Height, projection over water, good repair	**	12	
7-14		Piping and valves labeled, operating instruction available		13		
7-14		Main drain and skimmer(s) valved separately		14		
7-14, 15		3-2 Pump and filter: Approved, good repair, operating	**	15		
7-14		3-2 Pump strainer: 2 baskets in good condition, not clogged		16		
7-15		Gauges operable; Filter inlet and outlet, strainer; sight glass		17		
		3-2 Flow rate & pool volume posted		18		
7-14		Flow meter, flow rate OK: Required _____ gpm Observed _____ gpm		19		
7-16		Disinfectant/pH controls; approved, operating: Gas Cl OK	**	20		
7-11		Spa therapy piping independent of filter system		21		
7-14, 17		Thermometers: 3 required at heated facilities (1 handheld)		22		
<b>Bath House</b>		5-1.2, 7-6	No cross conn., pool makeup, hose bib: Backwash discharge OK	**	23	
	7-13	3-2 App. Chemicals: original containers, labeled, stored safely		24		
	7-7	3-2 Floors, Walls, Ceilings, Furniture: clean, good repair		25		
	7-7	3-2 Showers: Warm water, temperature control, good repair, soap		26		
	7-7	3-2 Toilets: Clean, good repair, supplies		27		
	7-7	Fire exting.; emerg exit marked & unlocked: drinking fountain		28		
	7-17	3-2, 9, 10 Records kept: Required testing done; Inspection posted		29		
	<b>Water Quality</b>		3-7 Turbidity: water clear, main drain visible	*	30	
			3-7 Free available chlorine ≥ 1 ppm, bromine ≥ 2 ppm	*	31	
			3-7 Combined Chlorine less than 0.2 ppm		32	
			3-7 pH between 7.2 and 7.8	*	33	
			3-7 Total Alkalinity between 80 and 200 ppm		34	
		3-7 Calcium hardness between 50 and 500 ppm		35		
		3-7 Water balanced within 0.5 pH units		36		
		3-7 Other: Cyanuric acid 30-100 ppm; TDS, metals controlled at spa		37		
7-11		3-7 Temperature of spa not over 105 °F	**	38		
<b>Other</b>		7-19	Electrical: GFI's, bulbs protected, no exposed wiring		39	
		7-8, 18	3-7 Lighting, ventilation, pool & air temperature comply	**	40	
		63 OS 1991, §1-1015	Any condition, act or omission endangering health or safety	**	41	

- \* Imminent Hazard - requires immediate correction or closure (See Back)
- \*\* Hazard - requires 72 hour correction (See Back)

### WATER QUALITY TESTS

Chlorine: Free \_\_\_\_\_ Combo \_\_\_\_\_  
 Bromine (Total) \_\_\_\_\_  
 pH \_\_\_\_\_ Water Bal Pt \_\_\_\_\_  
 Total Alkalinity \_\_\_\_\_  
 Calcium Hardness \_\_\_\_\_  
 Cyanuric Acid \_\_\_\_\_  
 Total Dissolved Solids \_\_\_\_\_  
 Water \_\_\_\_\_ °F Air \_\_\_\_\_ °F  
 Copper \_\_\_\_\_ Iron \_\_\_\_\_  
 Bact/Sample \_\_\_\_\_  
 Other \_\_\_\_\_

Received By \_\_\_\_\_ Title \_\_\_\_\_  
 Sanitarian \_\_\_\_\_ RS# \_\_\_\_\_  
 Supervisor \_\_\_\_\_ RS# \_\_\_\_\_

**\*IMMINENT HAZARD ITEM**

**ITEM IMMEDIATE CORRECTION OR CLOSURE REQUIRED SUMMARILY**

- 30 Turbidity: Main drain must be clearly visible.
- 31 Free Available Chlorine must be  $\geq 1.0$  ppm, Bromine  $\geq 2.0$  ppm.
- 33 pH must be between 7.2 and 7.8

**\*\*HAZARD ITEMS**

**ITEM MUST BE CORRECTED WITHIN 72 HOURS UNLESS OTHERWISE INDICATED**

- 01 Enclosure: Maximum opening anywhere, including bottom of fence, is 4" to protect toddlers. A gate standing open is a critical gap. Height required is 6' for OTGP and 4' for NOTGP. Construction shall not form a "ladder." Enclosure must allow observation from outside.
- 02 Lifeguard: At least one lifeguard must be on duty at pools OTGP. No lifeguard where one is required constitutes an imminent hazard.
- 05 Safety Equipment: Not required at spas and wading pools. Pools under 1600 sf require 2 ring buoys and one Shepherd's crook. Larger pools require twice the equipment and a backboard. A lifeline is required where there is a change in the bottom slope. Emergency telephones (non-coin) are required at all public bathing places. No safety equipment constitutes an imminent hazard.
- 07 Markings: Depth markers must be 4" tall and visible on the deck and vertical wall of the pool. No depth marking constitutes an imminent hazard. No depth markers are required at wading pools or at spas. At pools, striping is required on stair treads and risers, but not on recessed ladder treads. Ledges and recessed seats require striping, & barriers. The main drain cover must be a dark color or encircled by a wide contrasting stripe.
- 09 Outlet: All outlets must have an anti-vortex plate or the minimal 144 in<sup>2</sup> grate. A non-complying outlet constitutes an imminent hazard.
- 12 Diving Facilities: Pools with diving boards or platforms must be Permitted as diving facilities. Deck level boards must project 3' (min) to 4' (max) from coping to end of board; one and three meter boards, 5' (min) to 6' (max).
- 15 Pump & Filter: Recirculation systems must run continuously and provide required flow.
- 19 Flow: Flowmeter must be installed and operable. Design flowrate = 43 gpm min. for one skimmer, 86 gpm for 2 skimmers. Minimum turnover flowrate = 8 hrs, pool; 4 hrs, wading pool; 30 min, spa; 1 hr, slide. Required flowrate must be whichever is higher. Example: Design = 43 Minimum = 23, Required is at least 43 gpm.
- 20 Chlorinator: must be approved by the Department and properly installed; pH feeders, where required, must be in use. Gaseous chlorine setup must include scales and chains for cylinders, a valve stem wrench, and a gas mask; if enclosed, must include mechanical ventilation and light with switches on the outside, and viewport on the door. Gaseous chlorine facilities failing to comply with these features constitute an imminent hazard.
- 23 Cross connections: No direct connections between bathing place and potable water supply or sewer system are permitted. Air gaps are required. Backwash discharge shall comply with Section 4.
- 38 and 40 Temperature: Maximum water temperature of spas is 105°F; heated pools: 75° min., 90° max. Air temp. range (indoor) = water temp. -2° to +8°. Spa temperature > 105°F constitutes an imminent hazard.
- 41 Any observed conditions, acts or omissions or combination of demerit items which may endanger the health or safety of patrons of the public bathing place. (See remarks.)

**OTHER ITEMS**

**MUST BE CORRECTED BY NEXT INSPECTION UNLESS OTHERWISE INDICATED.**

**SUSPENSION NOTICE:** You are hereby notified that the license of this bathing place is suspended and all related operations are to be discontinued immediately. This suspension is because of the following condition(s) constituting an imminent health hazard.

\_\_\_\_\_  
\_\_\_\_\_  
This suspension shall remain in effect until re-inspection determines that the following corrective action has been accomplished.

\_\_\_\_\_  
\_\_\_\_\_  
Upon receipt of your request by the Director or his representative, that the above conditions no longer exists, your establishment will be granted a re-inspection within 24 hours. You have the right to submit, in the same manner, a written request for a hearing before the Director or Assistant Director to determine if the suspension was for probable cause and/or should be continued. Such hearing will be provided within 24 hours of receipt of request.

**REVOCATION NOTICE:** You are hereby notified that the license of this bathing place will be permanently revoked, five (5) days after the date of this notice, unless a written request for a hearing is filed with the Director or his representative within this five (5) day period. The reason for this revocation is for serious and/or repeated violations of Title 17 Chapter 12, Tulsa City Ordinances and/or Rules and/or Regulations of the State Board of Health, passed pursuant to Title 63, O. S.

# **Chapter 320**

## **PUBLIC BATHING PLACE OPERATIONAL REGULATIONS**

This Reprint Courtesy of

**Environmental Health Services**  
**(918) 595-4200**

**Tulsa City-County Health Department**  
**5051 South 129<sup>th</sup> East Avenue**  
**Tulsa, Oklahoma 74134**



## CHAPTER 320. PUBLIC BATHING PLACE OPERATIONAL REGULATIONS

<b>Subchapter</b>	<b>Section</b>	<b>Page</b>
1. General Provisions		
Purpose .....	310:320-1-1	1
Definitions .....	310:320-1-2	1
3. Operational Provisions		
Life saving equipment .....	310:320-3-1	6
Personnel.....	310:320-3-2	7
Rules and precautions for patrons.....	310:320-3-3	12
Safety provisions.....	310:320-3-4	13
Swimming suits and towels furnished by management ..	310:320-3-5	14
Wading and spray pool operation .....	310:320-3-6	14
Quality of bathing water.....	310:320-3-7	14
Table .....	310:320-3-8	15
Sampling and testing procedures .....	310:320-3-9	20
Satisfactory compliance - records .....	310:320-3-10	21
Winterizing and securing outdoor pools .....	310:320-3-11	22
Special conditions .....	310:320-3-12	22
5. Forms and Tables		
Portable pools .....	310:320-5-1	23
Water balance and water balance tables .....	310:320-5-2	24
Signs for storage of pool chemicals .....	310:320-5-3	26
Operation record form and instructions.....	310:320-5-4	26
Application for permit .....	310:320-5-5	26
Application guidelines .....	310:320-5-6	26
Figures .....	310:320-5-7	26

### Appendix

[Authority: 63 O.S. Supp. 1981, Sections 1-1017 et seq.]

[Source: Codified 12-31-91]



## SUBCHAPTER 1. GENERAL PROVISIONS

### 310:320-1-1. PURPOSE

The Public Bathing Place Operational Regulations are minimum design criteria and will be used as such by the State Department of Health. Nothing in these operational regulations should be construed as preventing the consulting engineer from recommending or the reviewing authority from approving, more effective treatment where local conditions dictate such action.

### 310:320-1-2. DEFINITIONS

**"Abrasion hazard"** — means a sharp or rough surface that would scrape the skin upon chance or by normal use modes.

**"Adjustable inlet"** — means a fitting mounted in the pool wall and connected to the return piping from the recirculation system that is directionally adjustable or a fitting mounted in the pool floor and connected to the return piping from the recirculation system that has a means of flow adjustment.

**"Air pump assist backwash"** — means the compressing of a volume of air in the filter effluent chamber (by means of an air compressor or by the water pressure from the recirculating pump) which, when released, rapidly decompresses and forces water in the filter chamber through the elements in reverse, dislodging the filter aid and accumulated dirt, carrying it to waste.

**"Air induction system"** — means a system whereby a volume of air (only) is induced into hollow ducting built into a spa floor, bench, or other location. The air induction system is activated by a separate air power unit (blower).

**"Attendant"** — means any person capable of providing rescue who is responsible to the management.

**"Backwash"** — means the process of thoroughly cleansing the filter media and/or elements by reverse flow.

**"Backwash cycle"** — means the time required to thoroughly backwash the filter media and/or elements and the contents of the filter vessel.

**"Backwash rate"** — means the rate of application of water through a filter during the cleaning cycle normally expressed in U.S. gallons per minute per square foot of effective filter area.

**"Bathing load"** — means the maximum number of persons allowed in the pool enclosure at one time.



- "Booster pump system"** — means a system whereby one or more hydrojets are activated by the use of a pump which is completely independent of the filtration and heating system of a spa.
- "Cartridge filter"** — means a filter that utilizes a porous cartridge as its filter medium.
- "Collector tank"** — means a tank receiving the gravity flow from the perimeter overflow gutter and main drain(s) from which the recirculation pump takes suction. It may be referred to as a balance tank.
- "Department"** — means the Oklahoma State Department of Health and authorized representatives.
- "Diatomaceous earth filter"** — means a filter that utilizes a thin layer of filter aid as its filter medium that periodically must be replaced.
- "Engineering nomenclature"** — means the technical terms used through these standards are understood to represent the currently accepted professional engineering definitions.
- "Filter"** — means a device that separates solid particles from water by recirculating it through a porous substance (a filter medium or element).
- "Filter agitation"** — means the mechanical or manual movement to dislodge the filter aid and dirt from the filter element.
- "Filter aid"** — means a type of finely divided medium used to coat a septum type filter, usually diatomaceous earth, processed perlite, or similar material.
- "Filter cycle"** — means the operating time between cleaning and/or backwash cycles.
- "Filter element"** — means a device within a filter tank designed to entrap solids and conduct water to a manifold, collection header, pipe, or similar conduit. Filter elements usually consist of a septum and septum support.
- "Filter freeboard"** — means the clear vertical distance between the top of the filter medium and the lowest outlet of the upper distribution system in a permanent media filter.
- "Filter media, permanent"** — means a finely graded material (such as sand, anthracite, etc.) which removes filterable particles from the water.
- "Filter septum"** — means that part of the filter element consisting of cloth, wire screen, or other porous material on which the filter medium or aid is deposited.

- "Filtration flow"** — means the rate of flow, in volume per time (GPM, GPH), through the filter system installed per manufacturer's instructions with new clean media.
- "Filtration rate"** — means the rate of filtration of water through a filter during the filter cycle expressed in U.S. gallons per minute per square foot of effective filter area.
- "Hydrojets"** — means a fitting which blends air and water creating a high velocity, turbulent stream of air enriched water.
- "Hydrotherapy, whirlpool, or spa pool"** — means a public pool used exclusively in conjunction with high velocity air and/or high velocity water recirculation systems, utilizing hot, cold, or ambient temperature water. These pools will be referred to as spas.
- "Individual therapy units"** — means tanks which are designed for the therapeutic treatment of one individual at one time and are drained and cleaned after each individual use. Individual therapy units are not considered public bathing places.
- "Ladders"** — means a series of vertically separated treads or rungs either connected by vertical rail members or independently fastened to an adjacent vertical spa/pool wall.
- "Lower distribution system" (underdrain):** — means those devices used in the bottom of a permanent media filter to collect the water uniformly during the filtering and to distribute the backwash uniformly during the backwashing.
- "Open to the general public"** — means not restricted to tenants or guests.
- "Overflow system"** — means the term overflow system encompasses perimeter type overflows, surface skimmers, and surface water collection systems of various design and manufacture. The water line shall be established by the height of the overflow rim.
- "Perimeter overflow gutter"** — means a trough or gutter around the inside perimeter of the pool walls with the overflow lip effecting a skimming action to clean the pool water surface.
- "Permanent media filter"** — means a filter that utilizes a medium that can be regenerated and will not have to be replaced.
- "Plunge pool"** — means the receiving body of water located at the terminus of a recreation water slide.
- "Pool deck"** — means the unobstructed area around the outside of the pool curb, diving boards, diving towers, and/or pool slides.
- "Pool floor"** — means the interior bottom pool/spa surface and consists of that surface from a horizontal plan up to a maximum of a 45° slope.

**"Pool turnover"** — means the circulation of a quantity of water equal to the pool volume through the filter and treatment facilities.

**"Portable pool"** — means a shallow pool, with depth not exceeding 4.5 feet, intended only for swimming instruction, which can be quickly erected, used for an instruction period then dismantled and moved to another location. Conditions governing authorization and operation are shown in the public Bathing Place Regulations and Public Bathing Place Facility Standards.

**"Precoat pot"** — A hopper with a valved connection to the suction side of the recirculation pump of pressure diatomaceous earth type filter systems that is used for coating the filter with filter medium prior to filtering water through the system.

**"Private pool"** — A pool maintained by an individual for the use of his family and friends, with no other formal admission requirement.

**"Public swimming pool or public pool"** — means a structure of concrete, masonry, or other approved materials, located wither indoors or outdoors, used for bathing or swimming, or for instructional purposes in swimming, diving, or other aquatic activities by humans, and filled with a filtered and disinfected water supply, together with buildings, appurtenances, and equipment used in connection therewith. A public swimming pool or public pool shall mean a conventional pool, spa type pool, wading pool, special purpose pool, or water recreation attraction to which admission may be gained with or without payment of a fee and includes but is not limited to pools operated by or serving camps, churches, cities, clubs, counties, health spas, institutions, parks, state agencies, schools, subdivisions, or other cooperative living type projects such as apartments, boarding houses, condominiums, hotels, mobile home parks, motels, recreational vehicle parks, and mobile home parks.

**"Recessed steps"** — means a riser/tread or series of riser/treads extending down from the deck with the bottom riser/tread terminating at the spa/pool wall, thus creating a "stairwell."

**"Recessed treads"** — means a series of vertically spaced cavities in the spa/pool wall creating tread areas for stepholes.

**"Recirculation system"** — means the system traversed by the recirculated water from the pool until it is returned to the pool (from the through collector tank, recirculation pump, filter, chemical treatment heater, if provided, and returned to the pool) .

**"Skimmer system"** — means the water line shall fall in the midpoint of the operating range of the skimmers.

- "Special purpose pool"** — means a public pool used exclusively for a particular purpose, including but not limited to springboard or platform diving training, scuba diving instruction, and aquatic programs for handicapped individuals and kindergarten children.
- "Spray pool"** — means a recreative area intended for use by children, in which water is supplied by a system of sprays but is not allowed to accumulate.
- "Steps"** — means a riser/tread or series of riser/treads extending down from the deck into the spa/pool area.
- "Toxic"** — means the adverse physiological effect on man.
- "Tread contact surface"** — means the foot contact surfaces of ladder, step, stair, or ramp.
- "Turnover rate"** — means the period of time (usually in hours) required to circulate a volume of water equal to the pool capacity.
- "Upper distribution system"** — means those devices designed to distribute the water entering a permanent media filter in a manner such as to prevent movement or migration of the filter medium. This system shall also properly collect water during filter backwashing unless other means are provided.
- "Vacuum (or suction) filter"** — means a filter which operates under a reduced pressure from the suction of a pump.
- "Wading pool"** — means a pool intended for recreative use by children and having a maximum depth not exceeding 18 inches.
- "Water line"** — means the water line shall be defined in one of the following ways: (See Skimmer System and Overflow System).
- "Water recreation attraction"** — means a public bathing or swimming facility with design and operational features that provide patrons recreational activity which is different from that associated with a conventional swimming pool and purposefully involves total or partial immersion in the water. Water recreation attractions include but are not limited to water slides, water amusement lagoons, and wave pools.

## SUBCHAPTER 3. OPERATIONAL PROVISIONS

### 310:320-3-1. Life saving equipment

- (a) **Adequate life saving equipment.** Adequate life saving equipment shall be provided at all public bathing places where the water is sufficiently deep for swimming and diving, to minimize the danger of drowning and of injuries to bathers from falls or collisions.
- (b) **Lifeguard chairs.** Each public bathing place open to the general public shall have at least one (1) elevated lifeguard chair. This shall be presumed to be adequate for two thousand (2,000) square feet of pool surface area with an additional lifeguard chair being provided for each additional area of two thousand (2,000) square feet or fraction thereof. Lifeguard chairs shall be located so that a lifeguard is not required to protect a segment in excess of one hundred eighty (180) degrees. Where a pool is provided with more than one (1) lifeguard chair and the pool width is forty (40) feet or more, chairs shall be located on each side of the pool. See Standards Section 310:315-7-3 and Regulations Section 310:320-3-2.
- (c) **Small pools.** Every swimming pool having a horizontal dimension of thirty (30) feet or less or a surface area of sixteen hundred (1600) square feet or less shall provide:
  - (1) One (1) or more poles each at least sixteen (16) feet in length. These shall end in a shepherd's crook with an opening of at least eighteen (18) inches and shall be constructed of light sturdy material such as aluminum or bamboo.
  - (2) Two (2) or more ring-buoys fifteen (15) to eighteen (18) inches in diameter, constructed of light material, such as kapok, with at least one-quarter (1/4) inch rope attached to reach the length of the pool, not to exceed forty (40) feet.
- (d) **Large pools.** For pools having a minimum horizontal dimension of more than thirty (30) feet or more than sixteen hundred (1600) square feet of surface area, the unit requirements listed under Standards Section 310:315-7-2 shall be doubled, and a backboard provided. The maximum length of pole required will be sixteen (16) feet. For large pools requiring more than two (2) lifeguard chairs, the requirements of Regulations Section 310:320-3-1 shall be provided for each chair.
- (e) **Life line.** A life line shall be provided at or near the break in grade between the shallow and deep portions of a public bathing place, with its position marked with colored floats spread on five (5) foot centers. Life lines shall be three-quarters (3/4) of an inch minimum diameter.

Terminals shall be securely anchored to a receptacle of corrosion-resistant material and of a type which will be recessed in to the pool wall. See Standards Section 310:315-7-4.

- (f) **Location of life saving equipment.** Life saving equipment shall be mounted in conspicuous places, distributed around the pool edge at lifeguard chairs, or elsewhere, ready of access, with its function plainly marked.
- (g) **First aid kit.** A completely stocked first aid kit shall be conveniently available at each bathing place. Contents shall be suitable for the type facility as recommended by the American Red Cross.
- (h) **Telephone.** A telephone to reach emergency assistance without the use of coinage shall be accessible to the pool during all hours of operation.

### **310:320-3-2. Personnel.**

- (a) **Transfer of ownership.** Each holder of a permit to construct a public bathing facility shall notify the Department in writing upon sale, lease, or other transfer of responsibility for the premises and shall supply the Department with the name and address of the new operator and/or owner.
- (b) **Operation and management.** The bathing place shall be maintained under the supervision and direction of a properly trained operator who shall be responsible for promoting good sanitation and safety, the proper maintenance of the bathing place, and all physical and mechanical equipment and records. Proper training can generally be obtained through attendance at short courses for swimming pool operators sponsored by the state, county, and municipal health departments; state colleges and universities; and organizations such as the YMCA, YWCA, and Red Cross. It is recommended that pool operators attend these training courses.
- (c) **Lifeguard.**
  - (1) One (1) or more lifeguards shall be on duty at the pool side of all bathing places open to the general public, and all pools with diving boards or platforms higher than one (1) meter at all times when the pool is open and in use. These individuals shall be in full charge and shall have authority to enforce all rules and regulations pertaining to sanitation and safety.
  - (2) Lifeguards of public bathing places in Oklahoma shall have satisfactorily completed an advanced course of instruction in life saving and water safety equivalent to that offered by the American Red Cross or YMCA. Lifeguards shall be carefully selected and shall

be not less than sixteen (16) years of age at the time they are employed as a lifeguard for duty at any public bathing place in Oklahoma. Lifeguards shall have a current life saving certificate, be capable swimmers, shall be competent in life saving methods, and be able to perform artificial respiration, shall be in good physical condition, and shall be able to command respect. At least one (1) person holding a current certificate in cardiopulmonary resuscitation (CPR) and trained in multi-media or equivalent first aid shall be on duty at all times the pool is in use. A current advanced life saving certificate for each lifeguard employed shall be prominently displayed or posted at the checking stand or other convenient point so as to be easily read by the patrons. The CPR certificate(s) shall be similarly posted. Bathing places open to the general public with water depths of four (4) feet or less may substitute persons passing an American Red Cross Basic Water Safety Course or its equivalent, rather than the Advanced Life Saving Course. It is recommended that, in addition, such persons also receive instruction in the shallow water "carries and assists" portion of the Red Cross Advanced Life Saving Course or its equivalent.

- (3) Lifeguards assigned to the pool side shall not be subject to duties that would distract their attention from proper observation and supervision of persons in the pool area, or that would prevent immediate assistance for persons in distress in the water.
- (4) The number of lifeguards on duty shall be such as to provide reasonable general supervision of the activities of all persons in the pool area, with detailed supervision and close observation of those persons in the pool water. The number shall also be sufficient to enable periodic relief or rest periods so that they will be alert while on duty. As a general approximation, it is recommended that the pool management provide at least one (1) lifeguard at the pool side for each seventy-five (75) persons in the swimming pool, with the determining factors being the type of pool, size of pool, ratio of surface area of deep water to the area of pool, temperature of the water, and quality of the water. Lifeguards shall wear distinguishing suits or emblems so that they may be easily identified by persons using the swimming facilities.
- (5) In the case of pools not open to the general public, that limit the use of the pool to their tenants or guests, it is recommended that a lifeguard or attendant who is responsible to the pool management be in attendance when the bathing place is in use. No person shall be employed for this duty who has a known communicable disease. Pools not open to the general public which do not have attendants

present during all hours of operation must post a sign at the entrance to the pool area stating "NO LIFEGUARD OR ATTENDANT ON DUTY."

(d) **Duties and responsibilities of pool personnel.** The Oklahoma Public Bathing Place Act provides that all owners, managers, operators, and other attendants in charge of any public bathing place shall be responsible for the safety and sanitation of public bathing places. In addition to compliance with the other parts of these standards, the pool personnel must be responsible for the following:

- (1) Duties and responsibilities pertaining to bathers and general pool operation.
  - (A) See that all rules and regulations affecting the users of the bathing place are properly enforced.
  - (B) Report all drownings and accidents requiring hospitalization immediately to the local health authorities by telephone and in writing within seven (7) days. If there is no local health department, contact Environmental Services at the State Health Department, Oklahoma City, Oklahoma.
  - (C) Report to the operator or management any condition of the bathing place or equipment, which may be detrimental to its safe operation.
  - (D) See that showers are used and are operating properly.
  - (E) See that all persons known to be infected with a communicable disease are excluded from the pool.
  - (F) See that all persons who are under the influence of an intoxicating liquor or drugs are excluded from the shower rooms and the pool area.
  - (G) See that all doors and gates to the bathing place are locked when the bathing place is not in use or when the facility is closed for health or safety reasons. Signs stating "POOL CLOSED" shall be placed at all entrances to the pool when not open for use.
  - (H) Two (2) unannounced emergency drills each year are recommended, including at least one (1) with a water rescue, at all pools open to the general public.
  - (I) Submit required records of the pool operations to the county health department. In counties without a county health department, mail the operation record to the State Health Department.



- (J) See that animals are not allowed inside the pool enclosure.
  - (K) See that safety equipment is not tampered with or played with by bathers or used for anything other than its intended use.
- (2) Duties and responsibilities pertaining to the bathhouse and appurtenances.
- (A) See that walk areas, overflow gutters, counters, lockers, equipment, furniture, interior partitions, and walls are in good repair and are clean. Where porous deck coverings are used, they shall be disinfected with a one-hundred (100) ppm solution of chlorine at least once each day the facility is in use.
  - (B) See that floors of dressing rooms, shower stalls, and other interior rooms are scrubbed, using hot water with a suitable detergent, rinsed thoroughly, and disinfected daily. More frequent attention to floors is recommended during periods of heavy use. It is important that the floors be thoroughly clean prior to disinfection with chlorine compounds. The floors should be scrubbed with soap or a suitable detergent, using hot water, then disinfected with a 0.3 percent to 0.6 percent solution of available chlorine, or a suitable commercial cleaner and disinfecting agent may be used.
  - (C) See that toilet rooms and fixtures are kept clean, sanitary, and in good repair.
  - (D) See that liquid soap dispensers, paper towel dispensers, and toilet paper holders are kept adequately supplied.
  - (E) See that no food, drinks, debris, or foreign substances are thrown or carried into the pool. No glass containers of any type may be used in or near the pool. Beverages should be dispensed in paper cups to avoid the hazard of broken glass. Waste containers for disposal of used cups and food wrappers shall be located at convenient points within the walk areas.
  - (F) Exclude unauthorized persons from the bathing place area.
  - (G) Exclude spectators and non-bathers from the toilet rooms provided for the persons using public pool facilities.
- (3) Duties and responsibilities pertaining to mechanical equipment.
- (A) See that the pool is free from sediment and accumulations of lint and hair. See that the walls and bottom of the pool are free from dirt and discoloration and that the overflow gutters and skimmers are clean and flushing properly. See that the

- bottom and sides of the bathing place are brushed or suction cleaned as often as is necessary to keep the pool free of solids that may settle, algae, and slime.
- (B) See that the level of the water is maintained at such a height as to ensure a constant slight overflow into the overflow gutter when no bathers are in the pool.
  - (C) Operate the pool equipment so as to maintain a clear and safe water and be responsible for maintaining the disinfection residuals and other chemical parameters as given under Regulations Sections 310:320-3-7 and 310:320-3-8.
  - (D) Keep on hand at all times at least a two (2) week's supply of chemicals for disinfection and pH control of bathing water.
  - (E) Keep on hand diatomite filter aid sufficient for two (2) weeks' operation for filtration with diatomite filters, including diatomite skimming filters.
  - (F) When adjusting flow from inlets, give consideration to the fact that children, who are more susceptible to infectious diseases than older persons, will be more or less restricted to the shallow sections; the greatest pool loads with subsequent contamination are likely to come in this section of the pool. Inlets should be adjusted to provide approximately ten (10) PSI pressure on the effluent gauge when the filter is clean. Approximately seventy (70) percent of the water should return to the pool through the inlets in shallow portion of the pool.
  - (G) Provide for filtration plant operation.
    - (i) All bathing place operators shall know how to properly operate the filtration system and its appurtenances. These include hair catchers, filters, pumps, chemicals, and vacuum cleaners.
    - (ii) Where surface skimmers are provided as a means of control of flotation, bathing place personnel shall regularly insure that the flow of makeup water is adequate to assure proper skimming operation. Baskets or screens provided to trap large solids shall be cleaned regularly.
    - (iii) An adequate supply of septa and diatomite filter aid shall be available at all times where skimmer filters are provided. When two (2) or more skimmer filters are in operation, they shall be inspected periodically to ensure balanced operation.

- (iv) Pool volume and turnover rate shall be posted in the equipment area of all existing and all new pools.
- (4) Duties and responsibilities pertaining to water chemistry.
  - (A) Be responsible for taking all tests as per Regulations Section 310:320-3-8.
  - (B) No pool shall be allowed to remain open for use if the free active chlorine, pH, or turbidity are not within the limits required by these regulations as per Regulations Section 310:320-3-7. It is the responsibility of the pool personnel to close the pool if any one (1) of these three (3) are not within the required parameter limits.
  - (C) Store all chemicals in a safe manner and in an area not accessible to unauthorized persons. No chemical shall be stored in a container that does not have a complete label on it for that product.
  - (D) See that the proper chemicals are on hand for the type disinfection feeder in use. Hand feeding of chlorine is permitted only for super-chlorination or cleaning the pool. Only chemicals recommended by the manufacturer of solution or flow-through feeders should be used.
  - (E) Chlorine and pH readings from an electrode type automatic controller may be substituted, with approval of the Department, for three (3) of the four (4) required daily readings in Regulations Section 310:320-3-8.

### **310:320-3-3. Rules and precautions for patrons**

- (a) **Rules for pools.** Rules governing the use of pools, spas, and other public bathing places shall be displayed on signs large enough for easy reading which are posted at the entrance to the pool, dressing rooms, or other appropriate places. Sign shall provide, in similar language, that:
  - (1) A cleansing shower bath, using warm water and soap, must be taken before entering the pool.
  - (2) Persons with open wounds, bandages, or any symptom of communicable disease shall be prevented from entering the pool.
  - (3) Swimming alone is prohibited.
  - (4) At pools that do not have attendants or lifeguards on duty, children under twelve (12) years of age must be accompanied by an adult responsible for that individual child at the pool side.
  - (5) Running and rough play are prohibited in and around the pool.

- (6) "Cut-offs" should be hemmed.
  - (7) Excess body lotions should be removed prior to entering the water.
  - (8) Bathing load limits shall be posted and enforced. See Standards Section 310:315-7-3.
  - (9) "NO LIFEGUARD OR ATTENDANT ON DUTY" where appropriate. See Regulations Section 310:320-3-2.
- (b) **Precautions for spas.** Precautions for spa patrons shall be posted on a sign, which provides, in similar language, that "Persons who are pregnant, taking medication, or have any history of cardiovascular disease should consult a physician before entering hot water. Drugs and alcohol are prohibited."

#### **310:320-3-4. Safety provisions**

- (a) **First aid kit.** A completely stocked first aid kit meeting the requirements of the American Red Cross shall be on hand at each bathing place.
- (b) **Emergency telephone numbers.** Every bathing place shall provide, immediately adjacent to its telephone, a selected list of current telephone numbers for available doctors, ambulance services, hospitals, and police or fire department rescue squads.
- (c) **Life saving equipment.** All public bathing places shall provide and maintain in good condition adequate life saving equipment. See Regulations Section 310:320-3-1 for required equipment.
- (d) **Bathing load.** The bathing load must be observed and the limit enforced by the owner and management at all pools. Bathing load shall not exceed design standards as per Standards Section 310:315-7-3.

#### **310:320-3-5. Swimming suits and towels furnished by management**

- (a) **Suits and towels.** All swimming suits and towels used by and maintained for public use shall be thoroughly washed and sterilized after each use.
- (b) **Laundering of suits and towels.** Swimming suits furnished by the management of the bathing place must be washed with hot water and soap or detergent, rinsed, and thoroughly dried and sterilized by heat each time they are used, or an equivalent approved process shall be used.
- (c) **Clean suits and towels.** Clean swimming suits and towels shall not be permitted to come in contact with unwashed suits and towels or be stored on shelves or in baskets which have been used for storing dirty swimming suits and towels. The issuing of clean suits and towels at the same counters where dirty towels and suits are turned in shall be prevented.

### **310:320-3-6. Wading and spray pool operation**

- (a) **Operation.** All artificially constructed bathing places, including wading pools and spray pools using recirculation systems, shall be free of turbidity, algae, and slime or floating matter, and the water quality shall comply with the same standards as all other artificially constructed bathing places.
- (b) **Supervision.** A supervisor shall be present at all times when a wading pool is in use. The supervisor's main duties consist of maintaining proper conduct and guarding against accidents. Children over twelve (12) years of age should be permitted to enter the enclosure but not the pool. Children with open sores or cuts, bruises, etc., or any contagious disease should not be admitted to the pool. The pool should be operated on definite hours on prescribed days to secure proper discipline and parents' cooperation. This supervisor replaces lifeguards and other safety requirements.
- (c) **Drains.** Wading pool and spray pool drains shall have grates or covers complying with Standards Section 310:315-7-14. This stipulation shall apply to all existing wading pools and spray pools with recirculation systems, as well as those to be constructed.

### **310:320-3-7. Quality of bathing water**

The pool water of all artificially constructed public bathing places shall undergo treatment necessary to comply with the following standards:

<b>310:320-3-8</b>		<b>Minimum</b>	<b>Ideal</b>	<b>Maximum</b>	<b>Comments</b>
<b>A. Disinfectant Levels</b>	Free chlorine, mg/1 (ppm)	1.0	1.0 - 1.5	5.0	NOTE: Chlorine should be maintained at this level continually. Super-chlorinate regularly. See pH below.
	Combined Chlorine, Mg/1 (ppm)	None	None	0.2	If combined chlorine* is TOO HIGH you may have: <ul style="list-style-type: none"> <li>◆ Sharp chlorinous odors</li> <li>◆ Eye burn</li> <li>◆ Bacteria growth</li> </ul> *Combined chlorine is eliminated by super-chlorination
	Bromine, mg/1 (ppm)	2.0	3.0	4.0	NOTE: Health department officials should be consulted before use.
<b>B. Chemical Values</b>	pH	7.2	7.5	7.8	If pH is: TOO HIGH: <ul style="list-style-type: none"> <li>◆ Low chlorine efficiency</li> <li>◆ Scale formation</li> <li>◆ Cloudy water</li> <li>◆ Increased scaling potential</li> <li>◆ pH maintained too high</li> </ul> TOO LOW: <ul style="list-style-type: none"> <li>◆ Rapid dissipation of chlorine</li> <li>◆ Plaster/concrete etching</li> <li>◆ Eye discomfort</li> <li>◆ Corrosion of metals</li> </ul>
	Total alkalinity as CaCO <sub>3</sub> , mg/1 (ppm)	80	100	200	If total alkalinity is: TOO HIGH: <ul style="list-style-type: none"> <li>◆ Cloudy Water</li> <li>◆ Increased scaling potential</li> <li>◆ pH maintained too high</li> </ul> TOO LOW: <ul style="list-style-type: none"> <li>◆ pH bounce</li> <li>◆ Corrosion tendency</li> </ul>
	Undissolved solids, mg/1 (ppm) (Turbidity)	None	None	None	If undissolved solids are:
	Dissolved solids, mg/1 (ppm)	300	...	1500	If dissolved solids are: TOO HIGH: <ul style="list-style-type: none"> <li>◆ Chlorine may be less effective</li> <li>◆ Scaling may occur</li> <li>◆ Fresh water should be added to reduce solids</li> <li>◆ Salty taste, and</li> <li>◆ Dull water</li> </ul> TOO LOW: <ul style="list-style-type: none"> <li>◆ Total alkalinity may be too low</li> <li>◆ Aggressive water</li> </ul>

<b>310:320-3-8</b>		<b>Minimum</b>	<b>Ideal</b>	<b>Maximum</b>	<b>Comments</b>
<b>B. Chemical Values</b>	Hardness, as CaCO <sub>3</sub> , mg/1	50	125	500	If hardness is: TOO HIGH: ♦ Scaling may occur ♦ Water has bad "feel" ♦ Short filter tuns TOO LOW: ♦ Plaster or concrete etching may occur ♦ Corrosion
	Copper, mg/1 (ppm)	None	None	0.3	If copper content is TOO HIGH: ♦ Staining may occur, ♦ Chlorine dissipates rapidly, ♦ May indicate pH to low, corrosion, etc. ♦ Water may discolor, ♦ Filter may plug,
	Iron, mg/1 (ppm)	None	None	0.2 <u>0.3</u>	If iron content is TOO HIGH: ♦ Staining may occur, ♦ Chlorine dissipates rapidly, ♦ Water may discolor, ♦ Filter may plug
	Manganese, mg/1 (ppm)	None	None	0.05	If manganese content is TOO HIGH: ♦ Staining may occur
<b>C. Biological Values</b>	Algae	None	None	None	If algae are observed: ♦ Super-chlorine or shock treat pool ♦ Supplement with brushing and vacuuming ♦ Maintain adequate free chlorine residual ♦ Use approved algaecide according to label direction
	Bacteria	None	None	None	If bacteria count exceeds health department requirements: ♦ Super-chlorinate pool & follow proper maintenance procedures ♦ Maintain proper free chlorine residual

**310:320-3-8**

		Minimum	Ideal	Maximum	Comments
D. Stabilizer	Cyanuric acid, mg/1 (ppm)	30	...	100	If stabilizer is: TOO LOW: Chlorine residual rapidly destroyed by sunlight TOO HIGH: May exceed health department requirements
	Note: Stabilizer is not needed in indoor pools, and should not be used in hot water facilities. Cyanuric acid may triturate as alkalinity.				
E. Algaecides	Quaternary algaecides	...	...	...	NOT PERMITTED IN PUBLIC POOLS.
	Copper-based algaecides (nonchelated), mg/1 (ppm)	0.1	0.2	0.3	NOTE: Ineffective against some algae. Health department officials should be consulted before using. May contribute to staining.
	Copper-based algaecides (chelated), mg/1 (ppm)	0.1	1.0	3.0	NOTE: See above.
	Silver based, mg/1 (ppm)	0.5	1.5	3.0	NOTE: Precipitates with cyanuric acid. Ineffective against some algae. Health Department officials should be consulted before use.
F. Remedial Practices	Superchlorination Frequency	Monthly	When combined chlorine is 0.2 mg/1 (ppm) or more	Weekly	NOTE: See design sections.
	Required superchlorination Chlorine, mg/1 (ppm)	5	10	...	
	Required shock treatment chlorine, mg/1 (ppm)	10	...	...	
	Floccing frequency	Not recommended			NOTE: Health department officials should be consulted before using.
	Water replacement Hot Water Facilities	...	...	...	Change water and clean monthly as a minimum, more frequently when heavy use and chemical treatment difficulties are experienced



**310:320-3-8**

		Minimum	Ideal	Maximum	Comments
<b>G. Temperature</b>	Water Temperature °F, Hot Water Facilities	90°F	...	105°F	If temperature is: TOO HIGH: ♦ Threat to health of certain persons with high blood pressure ♦ Excessive fuel requirement ♦ Increased evaporation ♦ Bather discomfort ♦ Increased scaling potential ♦ Increased use of chlorine TOO LOW: ♦ Bather discomfort
	Swimming Pools (Artificially heated water)	75°F	...	90°F	
	Indoor Pools (air) Excluding hot water facilities	Water temperature plus 8° Max. Water temperature minus 2° Min.			
<b>H. Water Clarity</b>	Water Turbidity	Must be able to see main drain or 6-inch black disk on bottom of deepest part of pool from pool sidewalk.			If water turbidity is TOO HIGH: ♦ Chlorine level may be too low ♦ Filtration system may be inoperative ♦ Too turbid water may lead to drowning because of reduced visibility

**310:320-3-9. Sampling and testing procedures**

(a) **Bathing place operators.** As required by Regulations Section 310:320-3-2, all bathing place operators shall know how to perform the following:

- (1) Collect a sample for bacterial analysis.
- (2) Collect at proper places a representative sample for determination of applicable chemical and operational parameters required by Section 310:320-3-9.
- (3) Be able to perform all applicable chemical analyses and operational determinations required by Regulations Section 310:330-3-9. The D.P.D. method should be used for free and combined chlorine determination. Orthotolidine (OTO) is not an acceptable method for determination of free chlorine.
- (4) Observe the proper procedure of turbidity determination. Close pool any time the main drain cannot be seen from sidewalk. Determine cause and reduce turbidity to acceptable level before reopening pool.
- (5) Observe the water temperature in hot water pools and spas.
- (6) Balance the pool water in relation to pH, total alkalinity and calcium hardness as per Regulations Section 310:320-3-7 (see Regulations Section 310:320-5-2 for Tables) .

(b) **Sampling and testing required**

(1) Tests shall be made of pool water as follows:

Free chlorine .....	Four (4) times per day
Bromine (if applicable) .....	Four (4) times per day
PH.....	Four (4) times per day
Turbidity .....	Four (4) times per day
Combined chlorine.....	Daily
Turnover .....	Daily
Total alkalinity.....	Weekly
Calcium hardness.....	Weekly
Cyanuric acid .....	Weekly

(2) Hot water facilities (above 90°F). In addition to the above tests, the following shall be determined:

Temperature.....	Four (4) times per day
Copper .....	Weekly
Iron .....	Weekly
Total dissolved solids .....	Weekly

- (3) Bacteriological samples. Hot water facilities and pools open to the general public may be required to submit a sample weekly to the local or the state health department.

### **310:320-3-10. Satisfactory compliance of records**

- (a) The Operation Record Form provided for these reports is designed to serve all types of bathing places, but not all of the lines of items will be applicable to each bathing place. Therefore, the management of a facility will be responsible for maintaining records only on those line items of the report that apply to their bathing place. All bathing places must maintain information on turbidity, pH value and chlorine residual; and for pools using stabilized chlorine compounds, cyanuric acid testing is also required.
- (b) The law with reference to records shall be satisfied when records appropriate to the type of bathing place being operated are submitted to the county health department, or for those counties without a county health department, to the appropriate sanitarian.
- (c) **Record forms.** Public bathing place operation record forms may be obtained from either the county or the state health department. The information requested or indicated thereon must be filled in completely for each day the public bathing place is open to the public. Forms tailored to suit the needs of the management may be substituted for Department forms provided that all information required by these standards is included and the forms are submitted to the Department for approval prior to use.
- (d) **Posting of inspection sheet.** The inspection sheet filled out by an authorized representative of the Department, which indicates the sanitary condition of the public bathing place, must be posted and maintained in a conspicuous place easily visible to all who use the facilities.
- (e) **Laboratory reports.** The laboratory reports covering any chemical or bacteriological examination of the water in a public bathing place must be kept on the premises and made accessible to authorized representatives of the Department.
- (f) **Report to the county health department.** A copy of the cumulative daily operation record must be forwarded to the appropriate health department.
- (g) **Operation report form.** The public bathing place operation record forms are designed to cover one (1) full week of operation. As a general rule, an original and one (1) copy will be required. The original is for the permanent files of the operator. The copy shall be forwarded to the appropriate health department as indicated above.

- (h) **Frequency of reporting to the county health department.** The management of public bathing places operated on a year-round basis must, unless instructed otherwise, forward copies of the accumulated weekly reports to the appropriate health department once each month. The accumulated copies must be mailed immediately following the closing of the pool on the first Saturday of each month.
- (i) **Seasonally operated bathing places.** The management of public bathing places operated on a seasonal basis, for example, outdoor bathing places operated only during the warmer months, must, unless specifically instructed otherwise, forward copies of the operating records to the appropriate health department at the close of each week's activity. Weekly reports will enable the personnel of the county health departments to give more prompt assistance to those operators who obviously are having continuous operation difficulties than would be possible with monthly reports.

### **310:320-3-11. Winterizing and securing outdoor pools**

When the pool is closed, all gates shall be locked. All outdoor pools shall be secured in one of the following approved methods:

- (a) **Draining.** Drained and kept drained until put back into service; or
- (b) **Pools not drained or covered.** Turbidity shall be controlled so that the main drain is visible from the pool deck. Maintaining disinfectant concentrations will suppress alga growth, and maintaining water balance will protect concrete and metal surfaces.
- (c) **Covering.** Provide a pool cover of a type that is securely anchored to the deck area with bolts or similar hardware and capable of supporting a minimum of one thousand (1000) pounds. Water must not be allowed to accumulate on the top. Swimming in the pool with a partial cover is prohibited. If water is left in the pool, it should be drained below the tile and skimmers (eighteen (18) to twenty-four (24) inches) and kept chlorinated. The air should be blown out of the skimmer and fill lines. Lights should be stored on the deck or in the bottom of the pool and with switches taped in the off position.

### **310:320-3-12. Special conditions**

Should special conditions exist or circumstances be such that in the opinion of the manager or operator, certain items listed as requirements would not be applicable, then alternate items shall be submitted in writing to the Department for appraisal as an acceptable substitute for the requirement, and upon approval may be used.

## **SUBCHAPTER 5. FORMS AND TABLES**

### **310:320-5-1. Portable pools**

- (a) **Conditions governing operation.** The following conditions govern operation of portable pools:
- (1) To be used for instructional purposes.
  - (2) For installation only at public buildings where adequate toilet and other sanitary facilities are conveniently available and at other agencies historically engaged in swimming instruction; i.e., Red Cross, YMCA, etc.
  - (3) The pool(s) to have continuous supervision by instructors or supervisors meeting requirements of these standards for life-guards.
  - (4) Instruction classes to be sized on the basis of one (1) pupil for each four hundred (400) gallons of pool volume.
  - (5) Use of the pool(s) to be limited to daylight hours unless the lighting requirements of these standards are met.
  - (6) The pool(s) to be covered and locked whenever unattended or out of use.
  - (7) The pool(s) installation at each location to be authorized by a permit issued by the Department for a scheduled period, preferably about two (2) weeks, extendable at the option of the county health department, upon receipt of a written request giving justification for the time extension.
  - (8) The operations of the pool(s) to be coordinated with the county health department for the purposes of inspections and supervision.
  - (9) Pool(s) to be located on paved surface with paved area and walkway from shower and toilet facilities to the pool.
- (b) **Application data required.** Application data required for portable pools is as follows:
- (1) Location(s) to be used.
  - (2) List of sanitary facilities available and the distance from the pool at each location. The number of showers, toilets, and lavatories for boys and girls.
  - (3) Square feet of paved ground available for each installation.
  - (4) The name of the owner of the installation; i.e., City of Oklahoma City.

- (5) The name and mailing address of the responsible individual and phone number; i.e., John Doe, Director of Recreation, City Park Department.
- (6) The duration of the term of instruction for which classes are to be scheduled for each location.
- (7) Each installation will require an application for permit with the above information.

### **310:320-5-2. Water balance and water balance tables**

- (a) Water balance is accomplished by adjusting the pH, total alkalinity, and calcium hardness in relation to each other. Tests are run on the pool water to determine the values for pH, total alkalinity, and calcium hardness. The accompanying table is used to determine scaling or corrosive potential of the water and to indicate corrective measures needed. Pools and spas that do not have balanced water are not only subject to considerable damage to the facility from scaling or corrosion but do not make effective use of free chlorine and indeed often have difficulty maintaining the required chlorine and pH levels. For more information, please contact your local health officials.

Recommended values are:

- (1) pH, 7.2 to 7.8
  - (2) Total alkalinity 80-120 ppm (pools), 100-150 ppm (spas)
  - (3) Calcium hardness 100-150 ppm (pools), 150-300 ppm (spas)
- (b) Directions to determine water balance point are as follows:
    - (1) Test the pool or spa water to determine the level of pH, total alkalinity, and calcium hardness.
    - (2) On the "Variable Temperature Water Balance Chart," (See Appendix A) locate the test values for total alkalinity and calcium hardness.
    - (3) Connect a line between values for Total Alkalinity and Calcium Hardness. Mark the intersection with a pivot line. This becomes the pivot point. Draw a horizontal line through the pivot point and the pH scales. Read the pH from the appropriate pH-Temperature Scale at the intersection with the horizontal line. This is the pH at which the water is balanced and is neither corrosive nor scaling.
    - (4) If the pool water pH value shown on the chart is no more than 0.5 pH above or below the actual observed pH in #1, above, then the water is in balance.

- (A) If the actual pool water pH is 0.5 units higher than the pH value indicated in the chart, then the water is considered scaling and will deposit calcium in lines, filters, and in the pool.
  - (B) If the actual pool water pH is 0.5 units lower than the pH value indicated in the chart, then the water is corrosive and will corrode the metal pipes, pump impellers, ladders, and other fixtures and will etch the pool plaster, making it "sandy."
- (5) Calcium hardness is the hardest of the three to balance. Therefore, using the actual calcium hardness value as a pivot point, move the line between 7.2 and 7.8 to see at what level the total alkalinity can be adjusted to balance the water. The pH should be adjusted first to between 7.2 and 7.8 (ideal is 7.6) and then the total alkalinity adjusted last. It is perfectly permissible to operate a pool at a slightly higher or lower pH than ideal (but within the 7.2 to 7.8 range) in order to balance the water.
- (6) Cyanuric Acid vs. Total Alkalinity. Cyanuric Acid will triturate as total alkalinity using the current field tests. The following is a conversion chart that may be used to determine the corrected value to Total Alkalinity:

<u>pH</u>	<u>Cyanuric Acid Factor</u>
6.0	.04
6.5	.10
7.0	.21
7.5	.30
8.0	.36
8.5	.38
9.0	.38

1. Test total alkalinity, pH, and Cyanuric Acid.
2. Multiply ppm Cyanuric Acid by Cyanuric Acid factor.
3. Subtract the product from the measured total alkalinity.
4. The result equals actual total alkalinity.

For example: With a pH of 7.5, Cyanuric Acid of 50 ppm, and Total Alkalinity of 150 ppm:

$$150 - (50 \times .30) = \text{Actual Total Alkalinity}$$

$$150 - 15 = 135 \text{ ppm Actual Total Alkalinity}$$

**310:320-5-3. Signs for storage of pool chemicals (See Appendix B)**

**310:320-5-4. Operation record form and instructions (See Appendix C)**

**310:320-5-5. Application for permit**

Contact Oklahoma State Department of Health, Consumer Protection Division

**310:320-5-6. Application guidelines for permits**

Contact Oklahoma State Department of Health, Consumer Protection Division

**310:320-5-7. Figures (See Appendix D)**





**APPENDIX A**

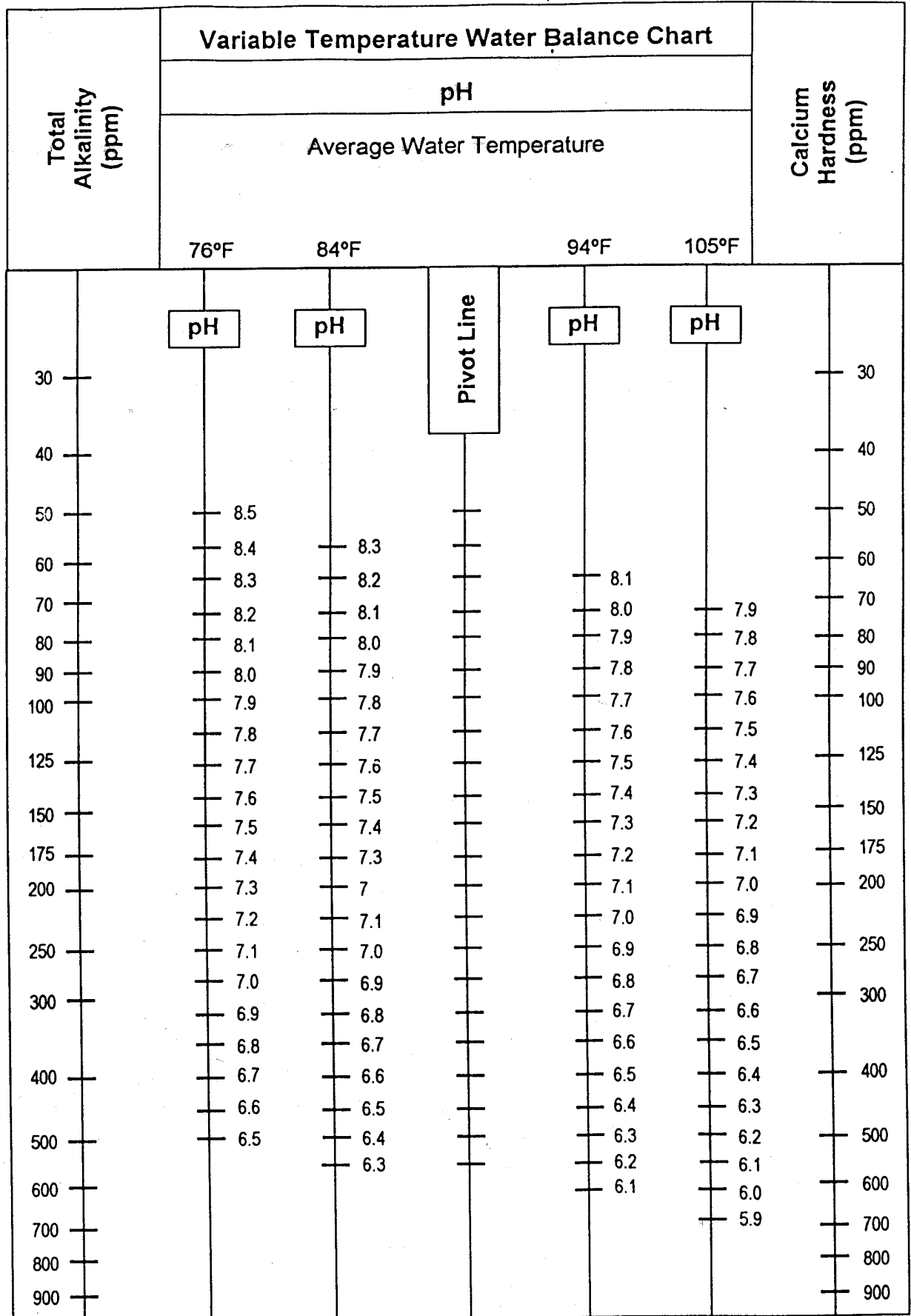



## APPENDIX B

Suggested signs to be used to indicate presence of pool chemicals

1. U.S. Department of Transportation sign — 4" square

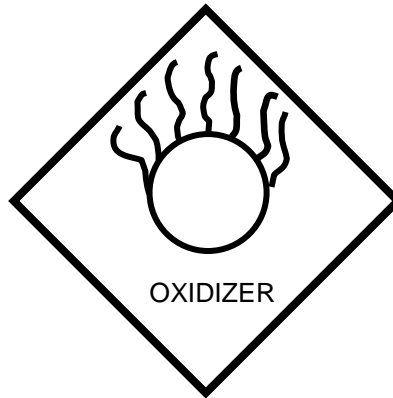

*yellow background*

2. National Firefighters Prevention Assn (NFPA) #704-1975, Standard System for the Identification of the Fire Hazards of Materials, adopted as follows for Pool Water Treatment Chemicals, — 12" square

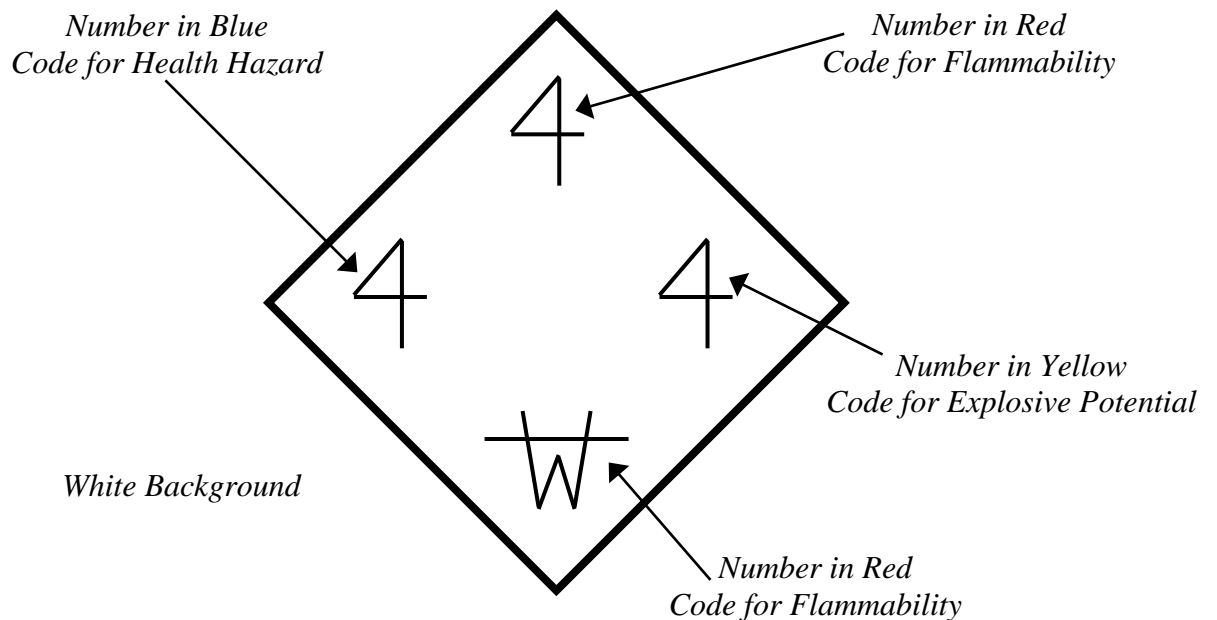

4 is the highest number on this scale (0 - 4 scale)



# APPENDIX D

## DIVING AREA – Schedule of Depths and Their Locations

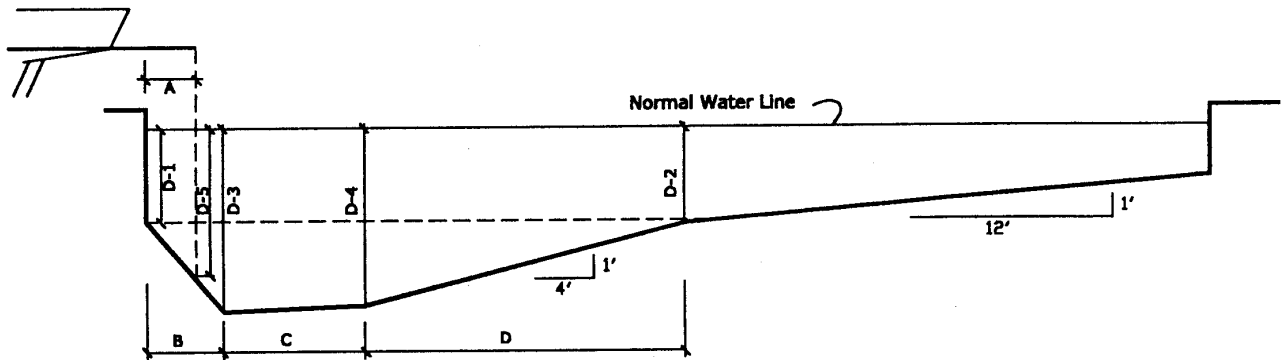
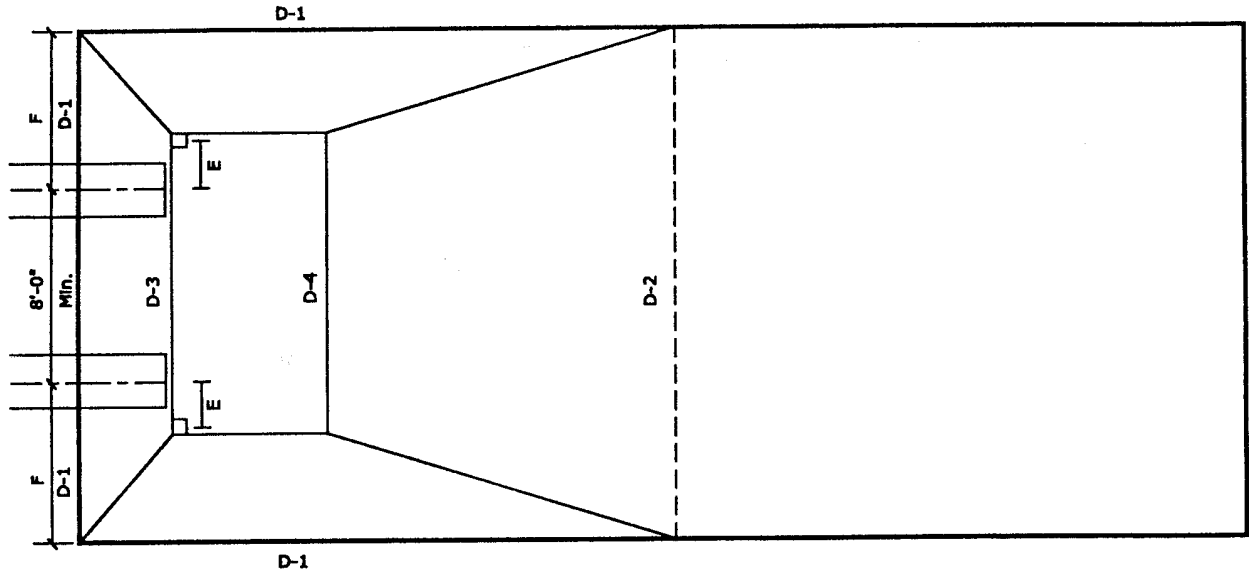

D-1 Side Wall Depth (See Section 10.6)

Stands & Boards		Depth-Minimum/maximum					Length of Section					
		D-1	D-2	D-3	D-4	D-5	A	B	C	D	E	F
3-Meter Board	Min	5'-0"	4'-6"	11'-0"	10'-9"	8'-6"	5'-0"	6'-0"	9'-0"	(c)	1'-0"	12'-0"
	Max		5'-6"				6'-0"	10'-0"	(a)			
1-Meter Board	Min	5'-0"	4'-6"	8'-6"	8'-3"	8'-0"	5'-0"	6'-0"	9'-0"	(c)	1'-0"	9'-0"
	Max		5'-6"				6'-0"	10'-0"	(a)			
Deck Level Board	Min	5'-0"	4'-6"	8'-0"	7'-6"	(d)	3'-0"	6'-0"	6'-0"	(c)	1'-0"	8'-0"
	Max		5'-6"				4'-0"	10'-0"	(b)			

Note: Distance between boards will not be less than 1' -0" vertical to horizontal.

(a) B & C may vary to attain 15'-0" min.

(b) B & C may vary to attain 12'-0" min.

(c) As D-2 varies between min. and max "D" may vary but slope of "D" may not exceed 1'-0" vertical to horizontal.

(d) See also Fig. II-A

Figure I

# Minimum Dimensions For Small Pools Having a Deck Level Diving Board

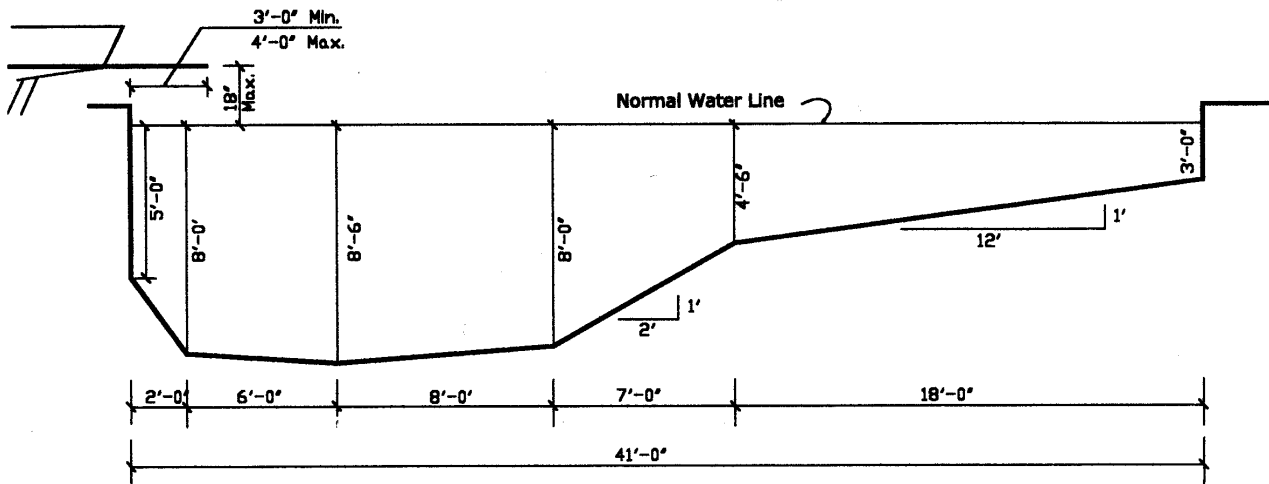
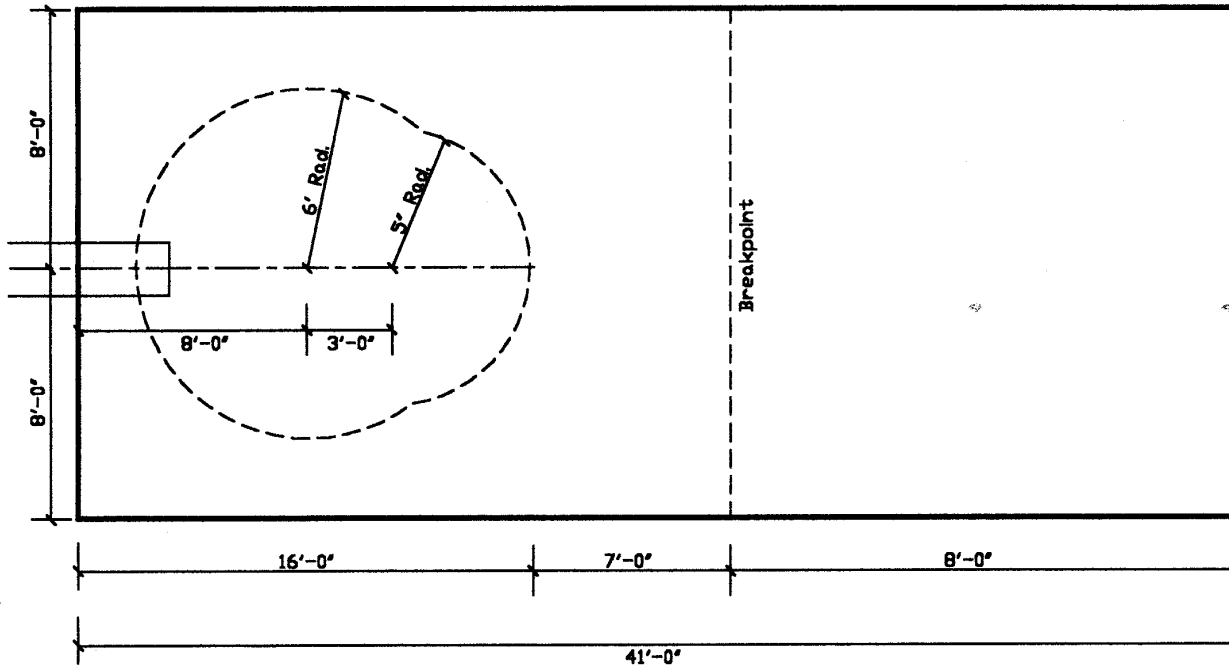
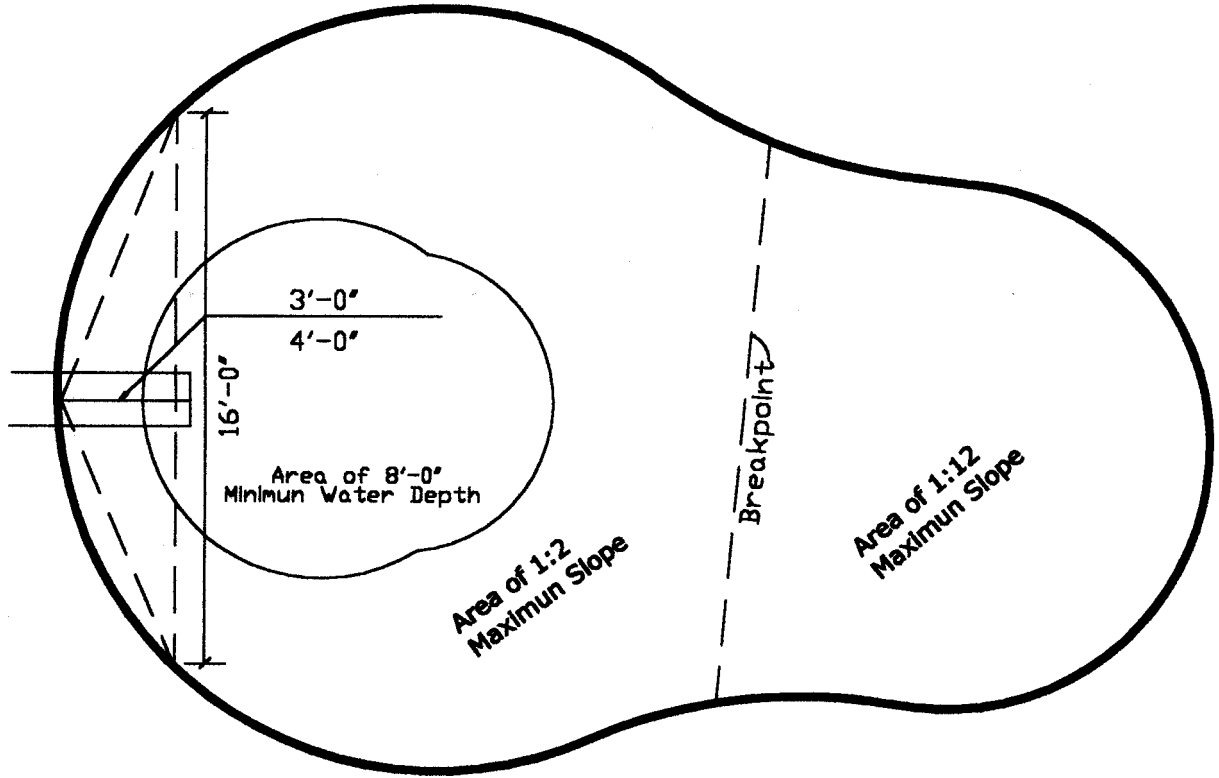

Figure II

# TYPICAL FREE FORM POOL DESIGN

Indicating Minimum Dimensions From Tip of Diving Board to Pool Wall



**POOL WALL SHALL REMAIN OUTSIDE OF TRIANGLE**

Figure II-A





**TULSA HEALTH**

Department